

HOW TO USE THIS SECTION

This Applications/Processing Guide is intended to provide you with points to consider for designing circuits, selecting trimmers and arranging board layouts, to achieve maximum performance and long life for your circuits and systems. We have also included information on steps your manufacturing engineers can take to preserve circuit reliability.

For example, are you aware that the trimmers and other mechanical components on your boards may face a more extreme environment during boardwashing on your own production line, than they ever will in use? For those trimmers that may need to be reset, are you remembering to select and mount the trimmers to provide easy accessibility?

In this section, you'll find dozens of pointers, reminders and useful facts that will help you be more knowledgeable and successful in using trimmers.

TRIMMER BASICS

In its most common form, a trimmer is simply a device containing a resistive element, and a wiper, or adjustable tap, contacting the element. The wiper can be mechanically moved to vary the amount of voltage or resistance in the circuit. The resistive element is usually laid out in linear or a circular configuration:

The Resistive Element

Trimmers for commercial applications typically have a resistive element made of carbon or cermet (a combination of CERamic and METal), or of resistance wire wound on an insulated copper mandrel.

The main advantages of wirewound trimmers are their low temperature coefficient, higher power dissipation, lower noise, tighter resistance tolerance, and, when used as a variable resistor, the excellent current-carrying capacity through the wiper due to the lower contact resistance. Also, their long-term resistance stability with time and temperature is slightly better than cermet.

Cermet trimmers provide a wider resistance range (10 ohms to 5 megohms, versus a maximum of 50K ohms for wirewound). Also, the wiper output can be set closer to the desired value since the resistive element presents a continuous contact surface for the wiper, as opposed to the discrete turns (resolution) of the wirewound. Other advantages with cermet are the lower reactance in high-frequency applications, the smaller sizes available, and the generally lower price than wirewound types.

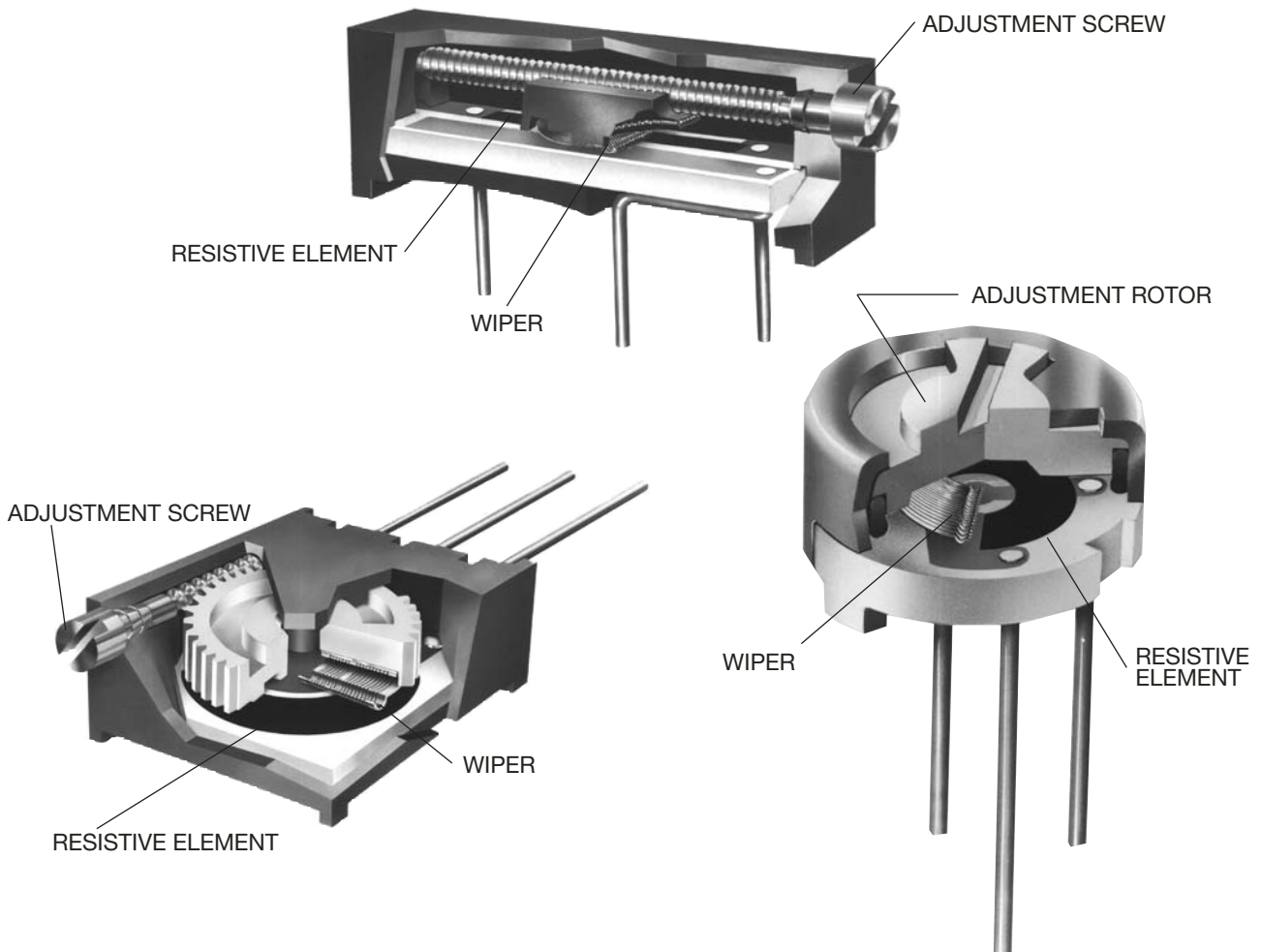

This application note is designed to provide step-by-step processing recommendations. It covers the popular SMC soldering processes currently in use and provides recommendations and cautions for each step. Since many variations of temperature, time, processes, cleaning agents and board types are found in the electronics industry, you'll want to test and verify your own system.

The process steps, recommendations and cautions are based on Bourns Trimpot surveys of SMC users, equipment manufacturers and materials suppliers. Also, comments reflect results of Bourns' testing. Our findings suggest the following soldering and cleaning processes:

1. **SOLDERING** - Forced Hot Air, Convection, IR, Vapor Phase (In-Line), Wave (Single and Dual)
2. **CLEANING** - Solvent, Aqueous, Semi-Aqueous, No-Clean
On the facing page are the common methods, materials and maximum temperature/time parameters for soldering and cleaning processes.



1 Solder Paste Printing

Reflow

GENERAL

Use the optimum solder paste for the pattern, printing process, solder paste density and solder joint quality.

RECOMMENDED

Use 8 to 10 mil thickness for solder paste print.

CAUTION

Since solder paste usually contains a high percentage of activators, you must ensure adequate cleaning to remove all residues, unless no-clean (low solids) paste is used.

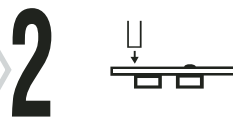

2 Adhesive Application

Flow (Wave)

GENERAL

The adhesive must hold the SM Component (SMC) in correct orientation upon placement and maintain correct trimmer position during physical handling before final solder processing.

RECOMMENDED

To assure positional stability, place a single dot of epoxy under the SMC.

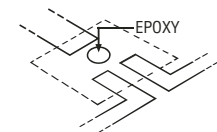

CAUTION

Stability after placement is a direct function of the volume of adhesive used. Use enough epoxy to assure stability through the cure process.

Avoid overflow of epoxy to solder pad and terminal areas.

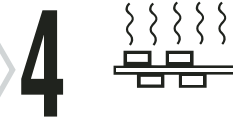
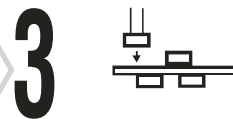

3 SMC Placement

GENERAL

Use pick-and-place equipment with vacuum nozzle ID size that allows adequate suction to pick the SMC out of the embossed cavity.

RECOMMENDED

The nozzle inside diameter (ID) should not exceed .100 in. (2.54mm) to ensure adequate suction and part alignment.

CAUTION

Assure parts are placed so that all terminals are equidistant (<4 mils) from the solder pads.

Align terminals with solder belt direction of travel to avoid body shadowing effects during flow soldering.

4 Adhesive Cure

Flow (Wave)

GENERAL

Use heat/time cure method with either convection oven or infrared radiation.

RECOMMENDED

Cure using the temperature and times recommended by the adhesive manufacturer.

CAUTION

Use enough cure time to assure complete adhesive transition from fluid to solid.



5 Flux Application

Flow (Wave)

GENERAL

Use the correct flux to remove surface oxides, prevent reoxidation and promote wetting.

RECOMMENDED

- RMA
- No-clean SRB (Synthetic resin based)
- OA (Organic Acid) (See caution)

CAUTION

Avoid highly activated fluxes. Consult factory before using OA.

SOLDERING/CLEANING METHODS

Process Step	REFLOW								FLOW				Material
	Hot Air; Infrared (Solvent)	Hot Air; Infrared (Semi-Aq)	Hot Air; Infrared (Aqueous)	Hot Air; Infrared (No-Clean)	Vapor Phase (Solvent)	Vapor Phase (Semi-Aq)	Vapor Phase (Aqueous)	Vapor Phase (No-Clean)	Wave (Solvent)	Wave (Semi-Aq)	Wave (Aqueous)	Wave (No-Clean)	
1. Solder Paste Printing	X	X	X	X	X	X	X	X					
2. Adhesive Application									X	X	X	X	
3. Component Placement	X	X	X	X	X	X	X	X	X	X	X	X	
4. Adhesive Cure									X	X	X	X	
5. Flux Application									X				Rosin
5. Flux Application										X			Rosin
5. Flux Application											X		Organic Acid
5. Flux Application												X	Synthetic Resin Based
6. Solder (Reflow)	X	X		X	X	X	X	X					63/37 Sn/Pb
7. Solder (Flow)									X	X	X	X	63/37 Sn/Pb
8. Wash (Solvent)	X				X				X				ODS Free
8. Wash (Semi-Aqueous)		X				X				X			Terpene, Hydrocarbon Based
8. Wash (Aqueous)			X				X				X		DI H2O; Surfactant; Saponifier
High Pressure Fluids			X				X				X		(See Caution)
Max. Temp. (°C)/Time (Secs)	235/40	235/40	235/40	235/40	215/180	215/180	215/180	215/180	260/5	260/5	260/5		
Min. Temp. (°C)	215	215	215	215	215	215	215	215	215	215	215		

6



Solder Reflow; Hot Air, IR and Vapor Phase

GENERAL
Preheat sufficiently using both time and temperature to vaporize all solder paste solvents and moisture, leaving only solder and flux as component enters solder reflow phase.

RECOMMENDED
Solder zone profile of 230 °C for 20 seconds.

CAUTION
Do not exceed time and temperature reflow profile of 235 °C for 45 ± 5 seconds for hot air/IR reflow.

Minimize thermal shock by limiting temperature rise rate to 3 °C/sec and by stabilizing board and components temperature during preheating.

Please click here to view our [recommended lead free soldering profile](#).

7



Solder Flow (Wave)

GENERAL
For maximum component reliability and performance, minimize the time of temperature exposure above 200 °C.

RECOMMENDED
Solder zone profile of 245 °C for 5 seconds.

CAUTION
Do not exceed 260 °C peak temperature for dual wave solder process with a flow zone totaling 5 seconds.

Minimize thermal shock by limiting temperature rise rate to 3 °C/sec and by stabilizing board and components temperature during preheating.

8



Wash Solvent

GENERAL
Use solvent cleaning primarily for nonpolar contaminants such as rosin based flux residues.

RECOMMENDED
Use any suitable washing solvents that meet ODC requirements.

CAUTION
Limit excessive direct spray pressure to 60 psi or below for optimum reliability.

9



Wash Semi-Aqueous

GENERAL
Use semi-aqueous for nonpolar contaminants such as rosin based flux residues.

RECOMMENDED
Use terpene or hydrocarbon based for pre-wash. Use water for final wash.

CAUTION
Limit excessive direct spray pressure to 60 psi or below for optimum reliability.

10

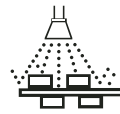

Wash Aqueous

GENERAL
Use aqueous cleaning primarily for polar contaminants such as organic flux residues.

RECOMMENDED
Use any of these aqueous wash materials:
• Deionized water
• Surfactants
• Saponifiers

CAUTION
Limit excessive direct spray pressure to 60 psi or below for optimum reliability. Ultrasonics may cause component damage or failure.

11

No-Wash

GENERAL
No-wash is an option when no-clean (low solids) flux is used for solder operations.

Board Rework Technique



RECOMMENDED
Hot air reflow technique is preferred.

GENERAL
Excessive and/or repeated high temperature heat exposure may affect component performance and reliability.

CAUTION
Avoid use of a soldering iron or wave soldering as a rework technique.

TRIMMING POTENTIOMETERS AND DEFINITIONS

The following terms and definitions have been edited from the Industrial Standard published by the Variable Resistive Components Institute. It is intended to encourage standardization in communication and understanding between the manufacturer and user. The complete standard, including detailed test procedures, is available upon request.

GENERAL TERMS

TRIMMING POTENTIOMETER: An electrical mechanical device with three terminals. Two terminals are connected to the ends of a resistive element and one terminal is connected to a movable conductive contact which slides over the element, thus allowing the input voltage to be divided as a function of the mechanical input. It can function as either a voltage divider or rheostat.

WIREWOUND TRIMMING POTENTIOMETER: A trimming potentiometer characterized by a resistance element made up of turns of wire on which the wiper contacts only a small portion of each turn.

NON-WIREWOUND TRIMMING POTENTIOMETER: A trimming potentiometer characterized by the continuous nature of the surface area of the resistance element to be contacted. Contact is maintained over a continuous, unbroken path. The resistance is achieved by using material compositions other than wire such as carbon, conductive plastics, metal film and cermet.

RESISTANCE ELEMENT: A continuous, unbroken length of resistive material without joints, bonds or welds except at the junction of the element and the electrical terminals connected to each end of the element, or at an intermediate point such as a center tap.

ADJUSTMENT SHAFT: The mechanical input member of a trimming potentiometer which when actuated causes the wiper to traverse the resistance element resulting in a change in output voltage or resistance.

SINGLE-TURN ADJUSTMENT: Requires 360° or less mechanical input to cause the wiper to traverse the total resistance element.

MULTITURN ADJUSTMENT: Requires more than 360° mechanical adjustment to cause the wiper to traverse the total resistance element.

TERMINAL: An external member that provides electrical access to the resistance element and wiper.

LEADWIRE TYPE TERMINAL: Flexible insulated conductor.

PRINTED CIRCUIT TERMINAL: Rigid uninsulated electrical conductor, suitable for printed circuit board plug-in.

SOLDER LUG TERMINAL: Rigid uninsulated electrical conductor, suitable for external lead attachment.

WIPER: The wiper is the member in contact with the resistive element that allows the output to be varied when the adjustment shaft is rotated.

STOP-CLUTCH: A device which allows the wiper to idle at the ends of the resistive element without damage as the adjustment shaft continues to be actuated in the same direction.

STOP – SOLID: A positive limit to mechanical and/or electrical adjustment.

STACKING: The mounting of one trimming potentiometer adjacent to or on top of another utilizing the same mounting hardware.

THEORETICAL RESOLUTION: (Wirewound only) The theoretical measurement of sensitivity to which the output ratio may be adjusted; the reciprocal of the number of turns of wire in resistance winding expressed as a percentage.

N = Total number of resistance wire turns.

$\frac{1}{N} \times 100$ = Theoretical resolution percent.

INPUT AND OUTPUT TERMS

TOTAL APPLIED VOLTAGE: The total voltage applied between the designated input terminals.

OUTPUT VOLTAGE: The voltage between the wiper terminal and the designated reference point. Unless otherwise specified, the designated reference point is the CCW terminal.

OUTPUT RATIO: The ratio of the output voltage to the designated input reference voltage. Unless otherwise specified, the reference voltage is the total applied voltage.

LOAD RESISTANCE: An external resistance as seen by the Output Voltage (connected between the wiper terminal and the designated reference point.)

ADJUSTMENT TERMS

DIRECTION OF TRAVEL: Clockwise (CW) or counterclockwise (CCW) rotation when viewing the adjustment end of the potentiometer.

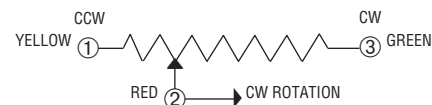

MECHANICAL TRAVEL — SOLID STOPS: The total travel of the adjustment shaft between integral stops. Continuity must be maintained throughout the travel.

MECHANICAL TRAVEL — CLUTCHING ACTION: The total travel of the adjustment shaft between the points where clutch actuation begins. Continuity must be maintained throughout the travel and during clutch actuation.

MECHANICAL TRAVEL — CONTINUOUS ROTATION: The total travel of the adjustment shaft when the wiper movement is unrestricted at either end of the resistive element as the adjustment shaft continues to be actuated.

ADJUSTMENT TRAVEL (ELECTRICAL): The total travel of the adjustment shaft between minimum and maximum output voltages.

CONTINUITY TRAVEL: The total travel of the shaft over which electrical continuity is maintained between the wiper and the resistance element.

ELECTRICAL AND OPERATIONAL CHARACTERISTICS

TOTAL RESISTANCE: The DC resistance between the input terminals with the wiper positioned to either end stop, or in dead band for continuous rotation potentiometers.

TEST VOLTAGE

Total Resistance, Nominal	Maximum Test Voltage	
	Non-Wirewound	Wirewound
Ohms	Volts DC	Volts DC
.1 TO 1.0	0.1	0.1
1.0 to 50	0.3	0.3
50 to 100	2.0	2.0
100 to 1000	3.0	3.0
1K to 100K	10	10
Over 0.1 megohm	50	—

NOTE: The test voltages should never exceed the equivalent of 10% rated power. The minimum voltage to be used is 10 MV.

ABSOLUTE MINIMUM RESISTANCE: The resistance measured between the wiper terminal and each end terminal with the wiper positioned to give a minimum value.

END RESISTANCE: The resistance measured between the wiper terminal and an end terminal when the wiper is positioned at the corresponding end of mechanical travel. Absolute minimum resistance and end resistance are synonymous for continuous rotation trimmers.

TEMPERATURE COEFFICIENT OF RESISTANCE: The unit change in resistance per degree Celsius change from a reference temperature, expressed in parts per million per degree Celsius as follows:

$$TC = \frac{R^2 - R^1}{R^1 (T^2 - T^1)} \times 10^6$$

Where:

R1 = Resistance at reference temperature in ohms.

R2 = Resistance at test temperature in ohms.

T1 = Reference temperature in degrees Celsius.

T2 = Test temperature in degrees Celsius.

RESISTANCE-TEMPERATURE CHARACTERISTIC: The difference between the total resistance values measured at a reference temperature of 25°C and the specified test temperature expressed as a percent of the Total Resistance.

$$RTC = \frac{R^2 - R^1}{R^1} \times 100$$

Where:

R1 = Resistance at reference temperature (25°C) in ohms.

R2 = Resistance at the test temperature in ohms.

CONTACT RESISTANCE VARIATION: The apparent resistance seen between the wiper and the resistance element when the wiper is energized with a specified current and moved over the adjustment travel in either direction at a constant speed. The output variations are measured over a specified frequency bandwidth, exclusive of the effects due to roll-on or roll-off of the terminations and is expressed in ohms or % of total resistance.

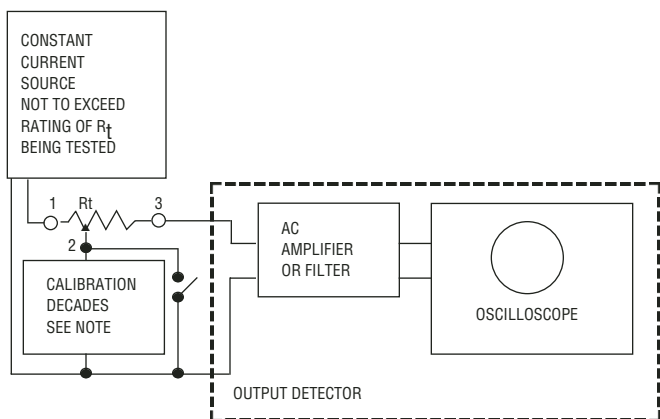

Figure 1. Contact-resistance-variation measuring circuit

Rt = Test specimen

Output detector bandwidth: 100 cycles to 50 kilocycles

Minimum input impedance to output detector:

At least 10 times the nominal resistance being tested

NOTE: At the calibration of the decade, terminals 1 and 2 must be coincident. Calibration decade is to be set for the contact-resistance variation (CRV) level of the specified nominal resistance being tested.

TABLE II

Test Current (±20%)	Total Resistance Range
30 ma	2 = Rt = 200
5 ma	200 · Rt = 3K
1 ma	3K · Rt = 200K
200 ua	200K · Rt = 1 megohm
50 ua	1 megohm · Rt = 5 megohm

EQUIVALENT NOISE RESISTANCE: Wirewound only. Any spurious variation in the electrical output not present in the input, defined quantitatively in terms of an equivalent parasitic, transient resistance in ohms, appearing between the contact and the resistive element when the shaft is rotated. The equivalent Noise Resistance is defined independently of the resolution, functional characteristics and the total travel. The magnitude of the Equivalent Noise Resistance is the maximum departure from a specific reference line. The wiper of the potentiometer is required to be excited by a specific current and moved at a specific speed.

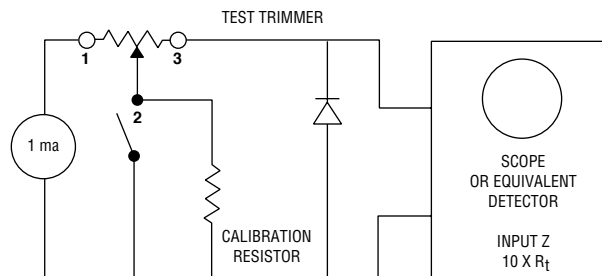

$$ENR \text{ (ohms)} = \frac{\text{Max. deviation (volts)}}{.001 \text{ amps}}$$

CONTINUITY: Continuity is the maintenance of continuous electrical contact between the wiper and both end terminals of the resistive element.

SETTING STABILITY: The amount of change in the output voltage, without readjustment, expressed as a percentage of the total applied voltage.

DIELECTRIC STRENGTH: The ability to withstand the application of a specified potential of a given characteristic, between the terminals and all other external conducting members such as shaft, housing and mounting hardware without exceeding a specified leakage current value.

INSULATION RESISTANCE: The resistance to a specified DC voltage impressed between the terminals and all other external conducting members such as shaft, housing and mounting hardware.

POWER RATING: The maximum power that a trimming potentiometer can dissipate across the total resistive element under specified conditions while meeting specified performance requirements.

ROTATIONAL LIFE: The number of cycles obtainable under specified operating conditions while remaining within specified allowable degradation. A cycle is defined as one complete traversal of the wiper over the resistive element in both directions.

LOAD LIFE: The number of hours at which a device may dissipate rated power under specified operating conditions while remaining within specified allowable degradations.

ADJUSTABILITY (OUTPUT RESISTANCE): The precision with which the output resistance of a device can be set to the desired value.

ADJUSTABILITY (OUTPUT VOLTAGE RATIO): The precision with which the output voltage ratio of a device can be set to the desired value.

MECHANICAL TERMS

STARTING TORQUE: The maximum moment in the clockwise and counterclockwise directions required to initiate shaft adjustment anywhere in the mechanical travel.

STOP TORQUE: The maximum static moment that can be applied to adjustment shaft at each mechanical stop for a specified period of time without loss of continuity or mechanical damage affecting operational characteristics.

SOLDERABILITY: The ability of the terminals to accept a uniform coating of solder under specified conditions.

WELDABILITY: The ability of materials to be welded together under specified conditions.

TERMINAL STRENGTH: The ability of the terminals to withstand specified mechanical stresses without sustaining damage that would affect utility of the terminals or operation of the trimming potentiometer.

IMMERSION SEALED: The ability of the unit to withstand submersion in acceptable cleaning solutions used in normal soldering processes without performance degradation under specified environmental conditions.

TRIMMER "ABILITIES"

When you are selecting components for a new design, you typically take into account the environmental conditions that the components will need to endure during the lifetime of the instrument or device. Designers in the past have often overlooked the environmental extremes of their own production lines, where the conditions may be much more severe than anything encountered in actual end use.

PROCESSABILITY

"Processability" refers to the ability of the unit to withstand the production-line processes associated with the finishing steps on the PC boards. Typically, both SMT and through-hole products are subjected to similar PC board processing operations after preparation for assembly. These operations can generally be summarized as follows:

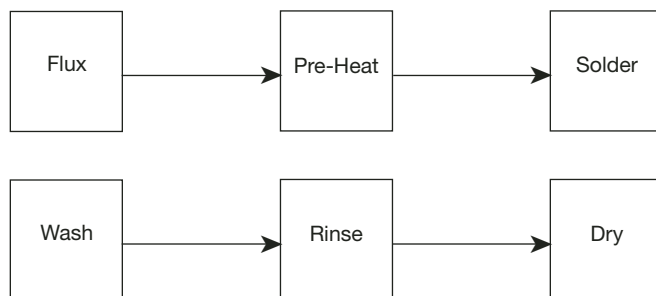

Soldering (SMT)

Four types of equipment are usually associated with SMT soldering:

IR System — Uses a multi-zone infrared furnace with IR elements heated to a temperature substantially above chamber or product temperature. Energy is supplied to the product primarily by IR radiation to reflow solder.

Forced Hot Air Convection System — Uses a multizone forced air convection system with heat source panels using IR or other type heating elements. Approximately 85% of the heating is provided by free convection to reflow solder on exposed PC boards.

Dual Wave System — Utilizes two parallel solder waves. The first is a turbulent wave followed by a laminar wave. The turbulent wave is for small, constricted areas, while the laminar wave removes solder projections.

Vapor Phase System — Provides a single-zone condensation heat source achieved with liquid fluorinated hydrocarbons that have been brought to the boiling point to create a saturated vapor zone. Heat is then released by the fluid's heat of vaporization as the vapor condenses on the product.

Soldering (Through-hole)

Two types of equipment are usually associated with through-hole soldering:

Single Wave System — Provides an inclined portion of the solder wave for the PC board to pass over. The PC board is positioned to bring many potential solder joints in contact with the wave simultaneously for a short time for soldering.

Drag System — Provides for PC boards to be dragged across the surface of the solder pot. Soldered connections are made during this operation.

PC Board Washing

Two types of equipment are usually associated with both SMT and through-hole products.

Pressure System — Accomplishes cleaning by directing sprays of water under high pressure from multiple nozzles.

Flooding System — Utilizes a combination of flooding (at normal water pressure) and surfactant action for cleaning.

Soldering and Wash Processes

Figure 1 shows typical profiles any component may see during a soldering and board washing operation. For details of material and process variables recommendations, see "Soldering and Cleaning Processes", page 76.

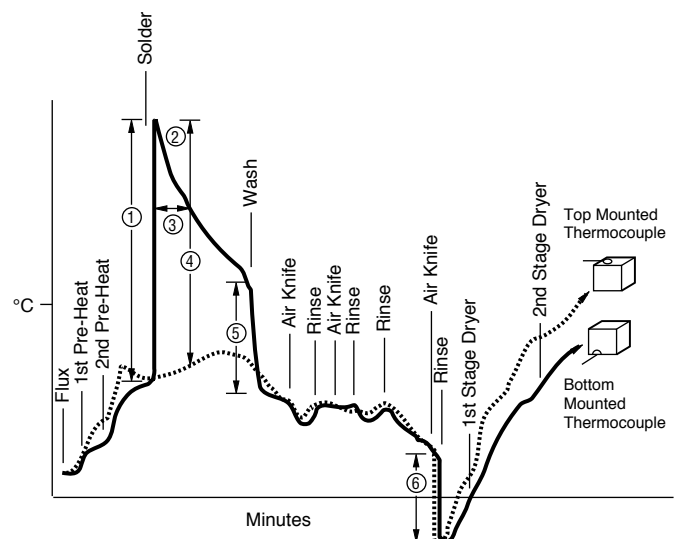

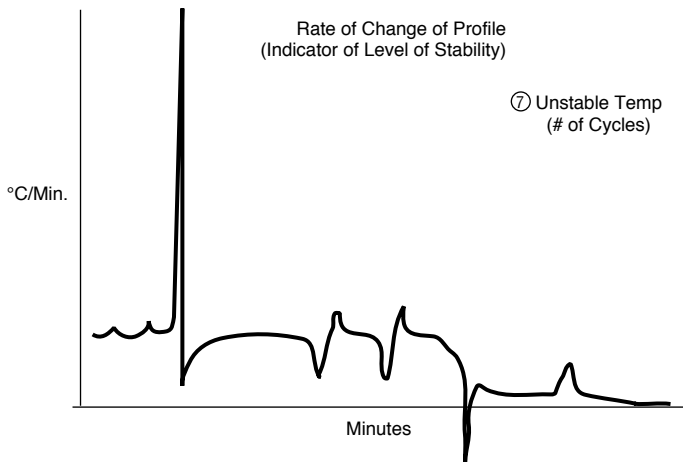

Figure 1.
Typical temperature profile for board washing and soldering.

Critical profile parameters

- ① Temperature Shock (°C)
- ② Maximum Temperature (°C)
- ③ Temperature Exposure (Minimum)
- ④ Temperature Gradient (°C)
- ⑤ Temperature Shock Decrease in Water (°C)
- ⑥ Temperature Shock Decrease in Water & Air Pressure (°C)
- ⑦ Unstable Temperature (see next page)

General Guidelines for Guarding Against Component Damage

To minimize temperature shock

- Pre-heat boards to maximum acceptable level
- Reduce time in solder

To avoid heating components above their maximum rated temperature

- Use lowest acceptable solder temperature
- Use maximum allowable conveyor speed
- Limit pre-heat temperature to maximum necessary

To limit time of exposure above rated temperature

- Limit time in solder
- After solder operation, cool board to wash temperature before it enters wash

To minimize temperature difference between top and bottom of board

- Apply pre-heat to both top and bottom

To reduce temperature shock on entering the moist environment of the wash

- Use wash/rinse temperature as near component temperature as possible
- Extend time between solder process and wash
- Cool board after solder operation, prior to entering wash

To minimize temperature variations as component travels through moisture

- Minimize number of wash/rinse and rinse/dry cycles
- Use heated air for air knives (to counter evaporative cooling effect)
- Minimize difference between wash and rinse temperature

To minimize exposure to high-pressure water during board wash

- Select trimmer models with pin styles that orient the rotor seal area away from exposure to the high-pressure water stream

SETTABILITY

Settability refers to the ease with which a trimmer can be set accurately to the position that produces the desired circuit condition.

Where the requirement is for obtaining a highly accurate setting the preference is for cermet — because a small incremental adjustment in a wirewound unit does not always produce the expected change in output as the wiper moves off one turn of wire and onto another.

Setting accuracy is better with a multiturn unit than with a single-turn. This is especially true when the speed of setting is also a requirement as on a production line (Figure 2).

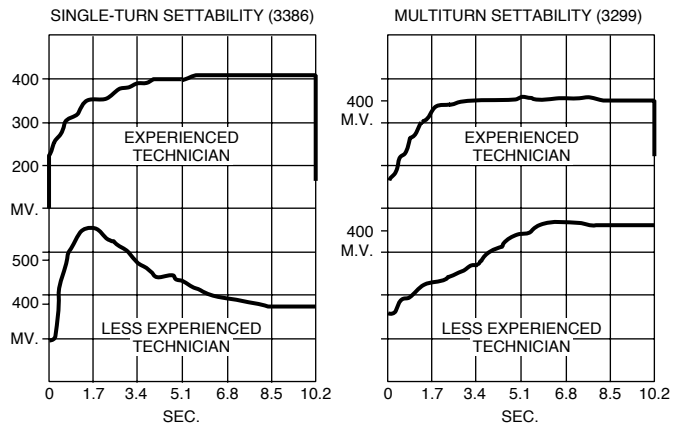

Figure 2.
When accurate setting is required, a multiturn trimmer can generally be set faster than a single-turn.

STABILITY

Stability refers to the ability of the trimmer to remain at the desired setting. Environmental factors play an important role here: stability may be affected by temperature exposure, thermal shock/cycling, humidity, and mechanical shock or vibration.

This is not a matter of concern in most applications, since Bourns trimmers exhibit excellent stability under all specified conditions. Stability is most often a concern when cermet trimmers are used in low current "dry" circuits (50uA amps and below). Under these conditions the contact resistance may vary, making the wiper appear unstable. This is most noticeable in some rheostat applications. This can be avoided by using a wirewound unit, or choosing a cermet trimmer that has been designed for dry-circuit applications. Bourns applications engineers can assist you on this and other questions.

ACCESSIBILITY

When selecting a trimmer and determining its placement on the board, keep in mind the people who will have to use it. Bourns trimmers are available in a wide variety of sizes, shapes, configurations, and placement of adjustment screws. You will usually find a unit on which the access for adjustment will be convenient for the user.

Keep in mind the different requirements for accessibility depending on whether adjustment will be done on the assembly line or in the field; with the board uncovered, in a housing or cabinet, or on an extender. Also consider whether production-line adjustment will be done manually or by robotics. A Bourns applications engineer can advise on special high-speed automatic adjustment features.

USABILITY

In selecting a trimmer for a specific application, it's important to be aware that the catalog contains a myriad of facts about each model that can assist you in finding the most suitable choice. For example:

Contact Resistance Variation (CRV) — Under MIL-R 22097 and MIL-R-39035, the maximum CRV is 3%. All Bourns trimmers meet this standard (3% or 3 ohms, whichever is greater). For applications that demand a more rigorous standard, some Bourns trimmers are rated at 2% or 2 ohms, and many others at 1% or 1 ohm.

Power Rating — The ambient temperature at which the trimmer will operate has an important bearing on power ratings. Power ratings are usually specified at 70° or 85°C; at a temperature of 150°C, the power rating of many trimmers is reduced to zero.

Temperature Coefficient of Resistance (T.C.) — This specification is a measure of how much the resistance changes with a change in temperature. In many applications a T.C. of $\pm 250\text{PPM}/^\circ\text{C}$ is acceptable. Typical T.C. specifications for cermet models are $\pm 100\text{PPM}/^\circ\text{C}$ and $\pm 50\text{PPM}/^\circ\text{C}$ for wirewound models.

RELIABILITY

One of the greatest challenges facing American manufacturers in the early '90s lies in the area of reliability — a challenge for component manufacturers and equipment manufacturers alike. Bourns has been on the leading edge of this effort, both in the area of instituting new methods and technologies for achieving higher reliability, and bringing an awareness of the need to other manufacturers.

SURFACE MOUNTED DEVICES (SMD)

AN EMERGING TECHNOLOGY

Surface mounting of electronic components represents another significant advance in PC board processing. Many U.S. companies have expressed an interest in SMD assembly methods to replace the often troublesome and costly techniques now used with leaded components. Unfortunately, for a number of reasons, this interest has not resulted to date in a major commitment to SMD handling equipment.

There are direct and indirect benefits associated with surface mounting. Since the direct benefits are outgrowths of the indirect ones, some explanation of these interrelated factors is required in order to understand this complex, highly technical and investment intensive subject. Further, a listing of the primary advantages will make additional comments on Japan's SMD usage and growth unnecessary.

In capsule format, the primary advantages (with comments on secondary benefits) are:

- **Lower End-Equipment Cost**
(positions OEM's for aggressive pricing to achieve market penetration).
- **Superior Product Performance**
(satisfies user requirements for improved operational performance).
- **Improved Product Quality and Reliability**
(creates confidence factor which easily translates to increased demand or sales).

- **Smaller Finished Product Size**

(addresses demand for miniaturization).

Cost, performance, quality/reliability and size — how are these factors interrelated and how are they achieved through surface mounting?

A by-product of SMD technology is the downsizing of components. Size reductions range from 25% to 60%, depending upon the device in question. High PC board densities can be achieved (more components per square inch of real estate; surface mounted units can also be assembled on both sides). PC board material savings alone are substantial. When circuits diminish, external hardware and other materials follow — further savings. Even freight charges are decreased by lighter equipment weight and less packaging.

Surface mounted component prices are forecasted to decline, the result of automated volume production. Volume is directly related to component standardization. By having a few sizes to cover a large range of electrical values and/or parameters, large quantities of a given device can be produced at a much lower per unit cost. Selling prices fall as volume increases. Component quality is also enhanced by eliminating many of the variables associated with short production runs.

Automatic SMD handling equipment, although capital intensive, is the single-most effective way to reduce labor costs and increase yields. Typical "pick and place" machines can assemble components 8 to 10 times faster than human assemblers, with virtually no mistakes. Major direct labor reductions are obvious. The combination of improved component quality and "mistake-free" component placement further decreases costs by eliminating the normal rework of auto-inserted boards.

The many advantages of SMD technology will force change upon both electronic equipment manufacturers and component suppliers alike. Worldwide competitive prices and performance pressures will make it happen. Few electronic components will escape its influence, trimming potentiometers being no exception. Bourns is committed to SMD conversion, and we intend to be a leader in surface mounted trimmer devices. Bourns surface mount trimmers begin on page 12.

GENERAL NOTES:

Plated-Through Holes: (Ref. MIL-STD-275D).

5.5 Plated-through holes. The difference between the inside diameter of the plated-through hole and the nominal outside diameter of the inserted lead shall be not greater than 0.028 inch (0.71 mm) or less than 0.010 inch (0.25 mm). Unless otherwise specified, the hole size shall be the finished plated size after solder coating or fusing. When flat ribbon leads are mounted through plated-through holes, the difference between the nominal thickness of the lead and the inside diameter of the plated-through hole shall not exceed 0.028 inch (0.71 mm).