

APPLICATION NOTE

Model TBU-CA Series - Modeling and Recovery Time Estimations



Model TBU-CA Series

INTRODUCTION

The Model TBU-CA Series of Bourns® TBU® products are low capacitance single bidirectional high-speed protection components, constructed using MOSFET semiconductor technology, and designed to protect against faults caused by short circuits, AC power cross, induction and lightning surges. The TBU® high-speed protector placed in the system circuit will monitor the current with the MOSFET detection circuit triggering to provide an effective barrier behind which sensitive electronics will not be exposed to large voltages or currents during surge events.

PURPOSE

This application note analyzes the behavior of the Model TBU-CA during a surge event, while protecting an active line, and determines the time and conditions required to recover to the operating state (the state where the TBU® device is passive and not protecting).

APPLICATION NOTE

Model TBU-CA Series - Modeling and Recovery Time Estimations



Model TBU-CA Series

SIMULATION

The test circuit in Figure 1 was simulated in order to understand the behavior of the TBU® device during a surge event. The circuit on the right side of Figure 1 represents an active signal, V_{SIGNAL} , ($V3$, $R2$, $D1$) into a load ($R3$) through an 850 V / 500 mA TBU® device (Bourns Part Number TBU-CA085-500-WH). The $D1$ diode is to help protect $V3$ from the 50 V surge.

Per the Model TBU-CA series data sheet, the series resistance of the Model TBU-CA085-500-WH is 10.7Ω , typical. Also, the leakage current (I_Q) of the TBU® device while in protected state is 0.50 mA, typical.

The left side of Figure 1 represents a 50 V / 10 A surge controlled by a switch. For the sake of simulation, a voltage-controlled switch ($S1$) is controlled by a 5 V pulse ($V2$) that is 1 ms long (ramp up = ramp down = 5 ns).

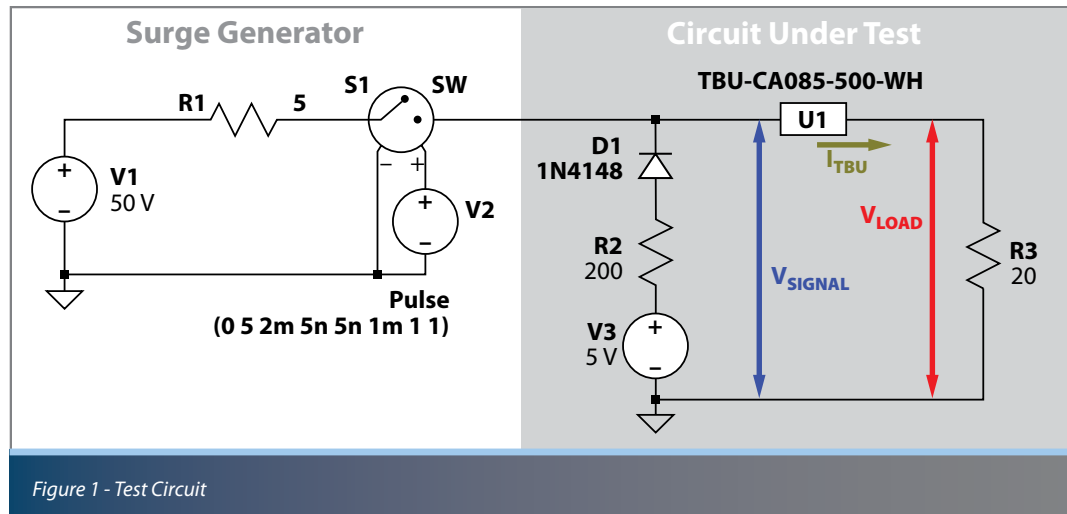

Figure 1 - Test Circuit

APPLICATION NOTE

Model TBU-CA Series - Modeling and Recovery Time Estimations



Model TBU-CA Series

SIMULATION (CONTINUED)

We can now compare the estimated values of V_{SIGNAL} , V_{LOAD} , and I_{TBU} , and measure the simulated values per the graph in Figure 2.

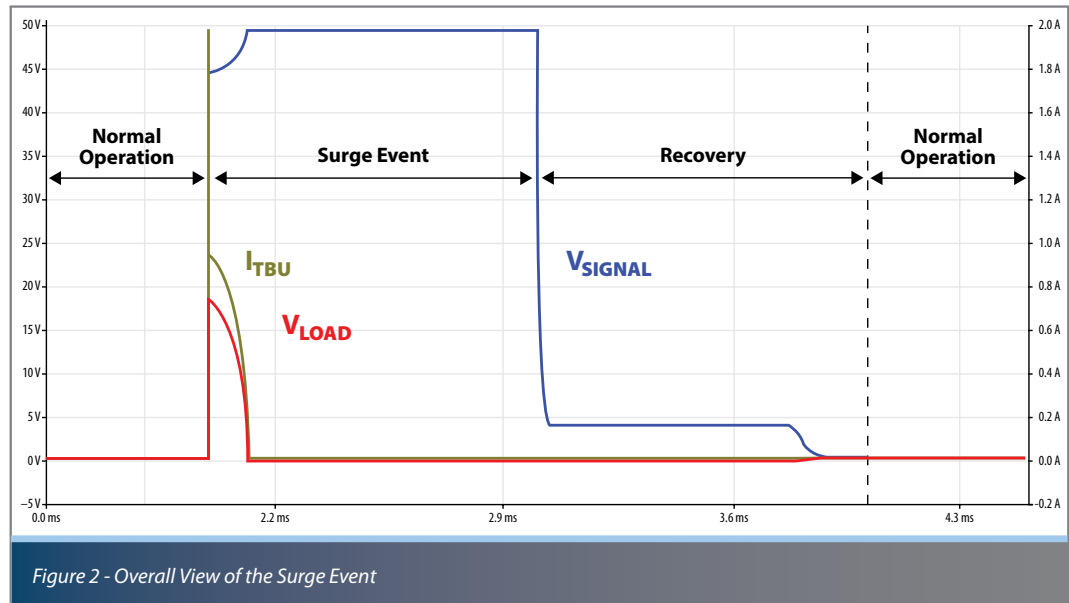

During normal operation, assuming that the voltage drop across D1 = 0.7 V and the TBU® device's $R_{\text{DEVICE}} = 10.7 \Omega$ (both values will be different depending on SPICE models):

$$I_{\text{TBU}} = \frac{5 - 0.7 \text{ V}}{(200 + 10.7 + 20) \Omega} = 18.634 \text{ mA}$$

Per the simulation, $I_{\text{TBU}} = 18.736 \text{ mA}$.

$$V_{\text{SIGNAL}} = 5 \text{ V} - (18.634 \text{ mA} \times 200 \Omega) - 0.7 \text{ V} = 572.215 \text{ mV}$$

Per the simulation, V_{SIGNAL} is 525.171 mV.

$$V_{\text{LOAD}} = 0.572 \text{ mV} - (18.634 \text{ mA} \times 10.7 \Omega) = 372.564 \text{ mV}$$

Per the simulation, V_{LOAD} is 374.722 mV.

During recovery, using the TBU® device's leakage current $I_{\text{Q}} = 0.5 \text{ mA}$:

$$V_{\text{SIGNAL}} = 5 \text{ V} - (0.5 \text{ mA} \times 200 \Omega) - 0.7 \text{ V} = 4.2 \text{ V}$$

Per the simulation, V_{SIGNAL} is 4.375 V.

APPLICATION NOTE

Model TBU-CA Series - Modeling and Recovery Time Estimations



Model TBU-CA Series

SIMULATION (CONTINUED)

Looking at the surge current in Figure 3 – Total time of the TBU® Device Going into Protected State (I_{TBU} decreasing to I_Q), the TBU® device's reaction time (current dropping I_Q) is about 120 μ s. The time it takes for the TBU® device to start blocking is approximately 40 ns (Figure 4).

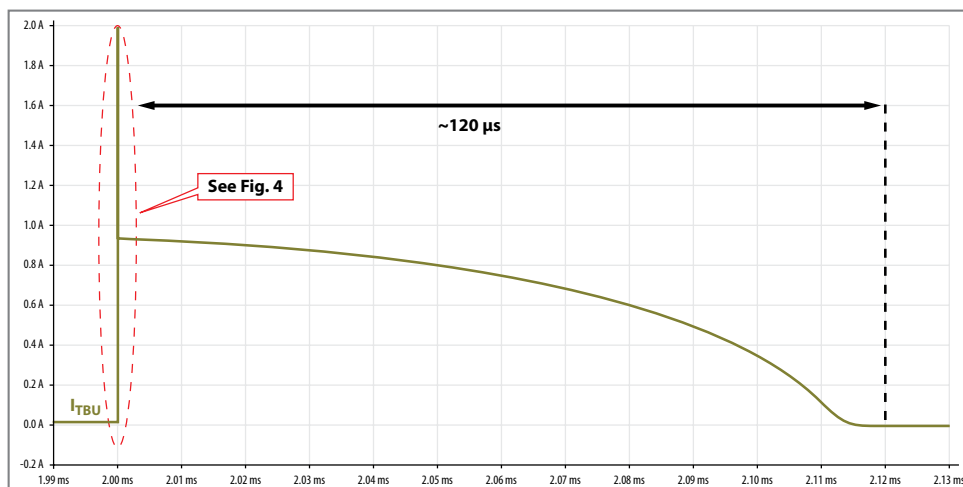

Figure 3 - Total Time of the TBU® Device Going into Protected State (I_{TBU} decreasing to I_Q)

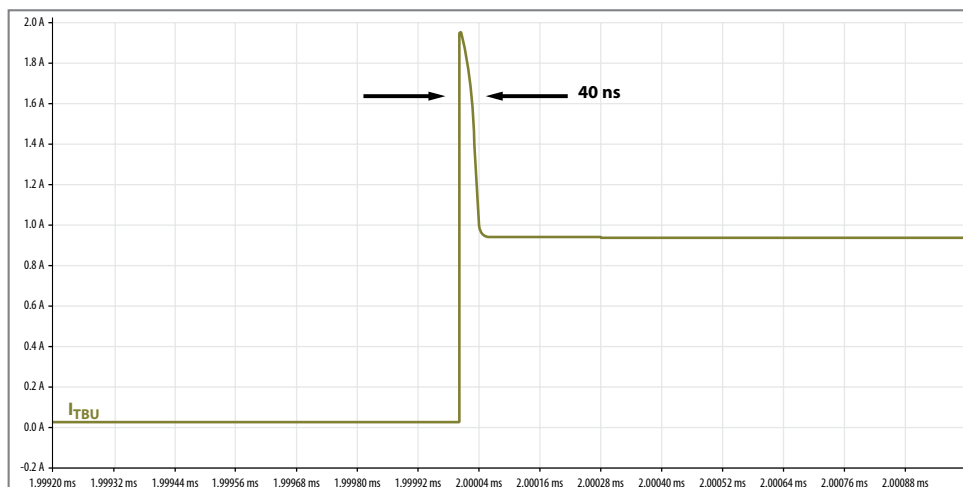

Figure 4 - Reaction Time of the TBU® Device to a surging I_{TBU}

Model TBU-CA Series - Modeling and Recovery Time Estimations



Model TBU-CA Series

SIMULATION (CONTINUED)

During recovery, the TBU® device is still in protected state. The TBU® device's leakage current (~0.5 mA) creates approximately 4.375 V at its input. The device stays in protected state for approximately 800 μ s and ramps down for approximately 200 μ s, back to normal operation. Per the simulation, we can approximate the total recovery time to be 1.0 ms \pm 15 %.

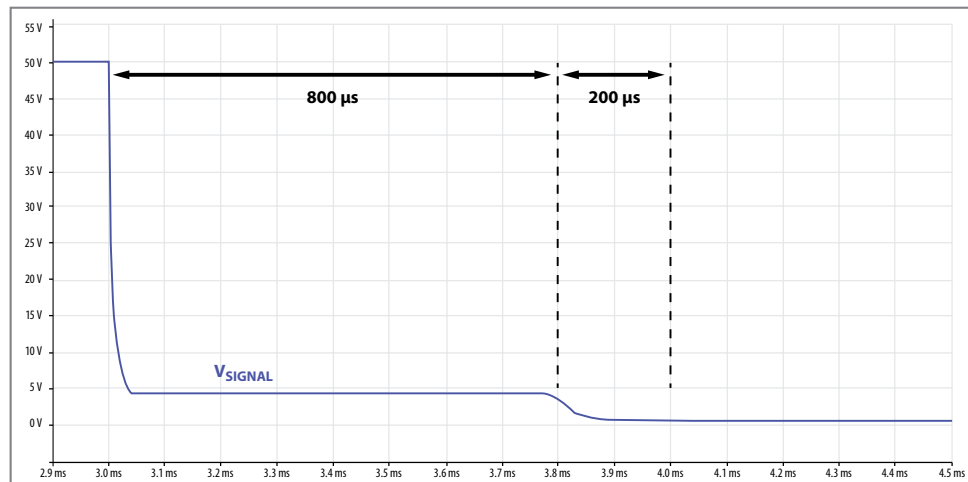

Figure 5 - Recovery at the Input of the TBU® Device

APPLICATION NOTE

Model TBU-CA Series - Modeling and Recovery Time Estimations



Model TBU-CA Series

SIMULATION (CONTINUED)

Next, we'll examine the TBU® device by looking at the voltage across it while varying the voltage source V3. This will help us understand the recovery times at different voltages, and how the device behaves as it approaches the reset voltage and above.

The simulated circuit is modified by stepping the V3 supply from 1 V to 20 V, 1 V at a time.

Per the data sheet, the Model TBU-CA reset voltage, V_{RESET} , is 12 V minimum. This is the voltage across the TBU® device.

As shown in Figure 6, the total recovery time for all signal levels is still within a microsecond of each other. But notice how at 17.40 V (when $V3 = 18$ V) the behavior starts to change and eventually, at higher voltages, the TBU® device does not reset.

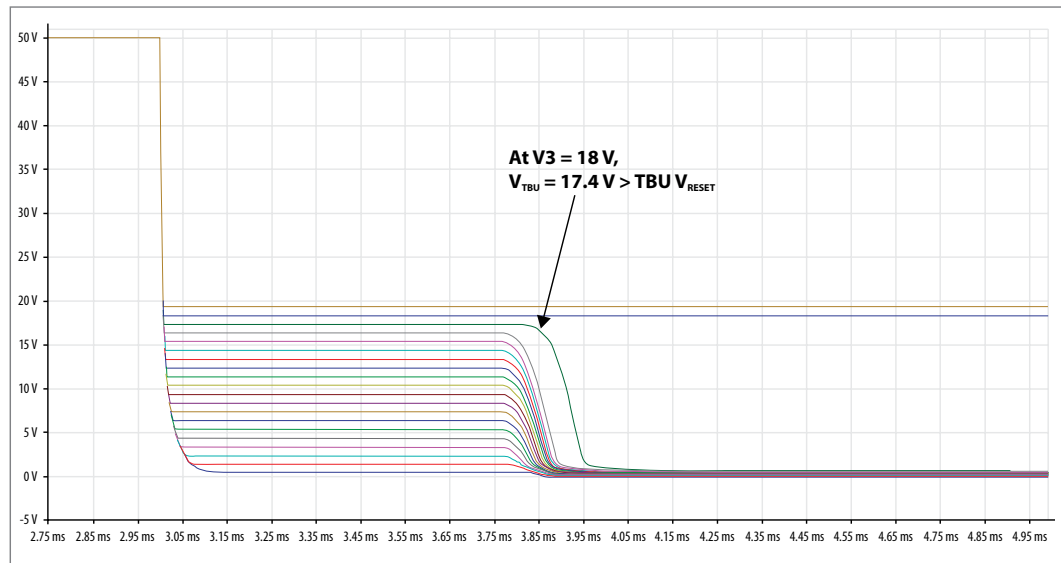

Figure 6 - Voltages Across the TBU® Device at Different Signal Levels, Simulation

Model TBU-CA Series - Modeling and Recovery Time Estimations



Model TBU-CA Series

BENCH TEST

The circuit was built to measure the actual behavior of the TBU® device. During normal operation, the surge event, and the recovery, we get the same behaviors as simulated, albeit a difference in timing (simulation vs. actual).

Starting at normal operation, Figure 7 demonstrates that V_{SIGNAL} and V_{LOAD} are very close to the estimated values, 575 mV and 375 mV, respectively.

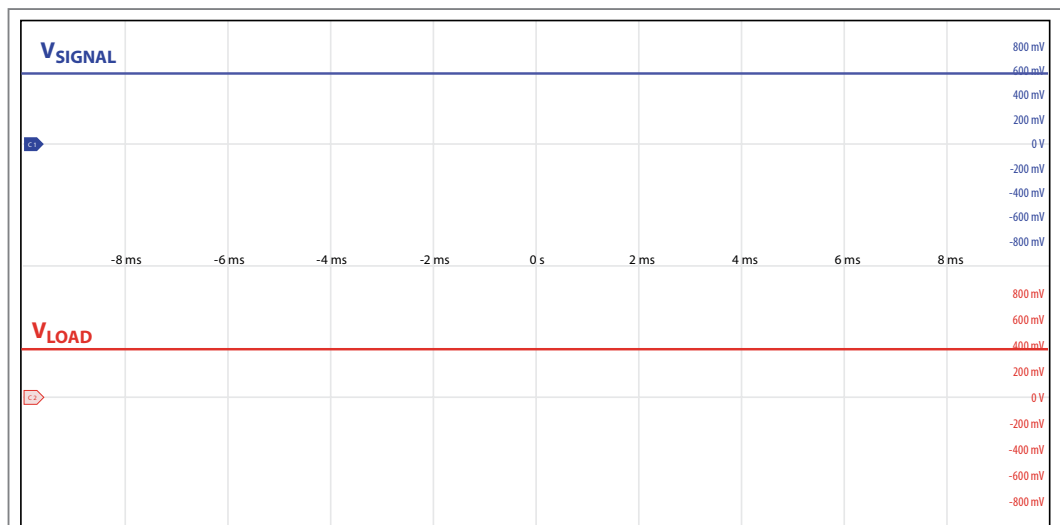

Figure 7 - Voltages at Normal Operation

Model TBU-CA Series - Modeling and Recovery Time Estimations



Model TBU-CA Series

BENCH TEST (CONTINUED)

Here in Figure 8, we can see the effects of the TBU[®] device triggering. While the reaction time is under 2 μs , the TBU[®] device goes into protected state within 36 μs .

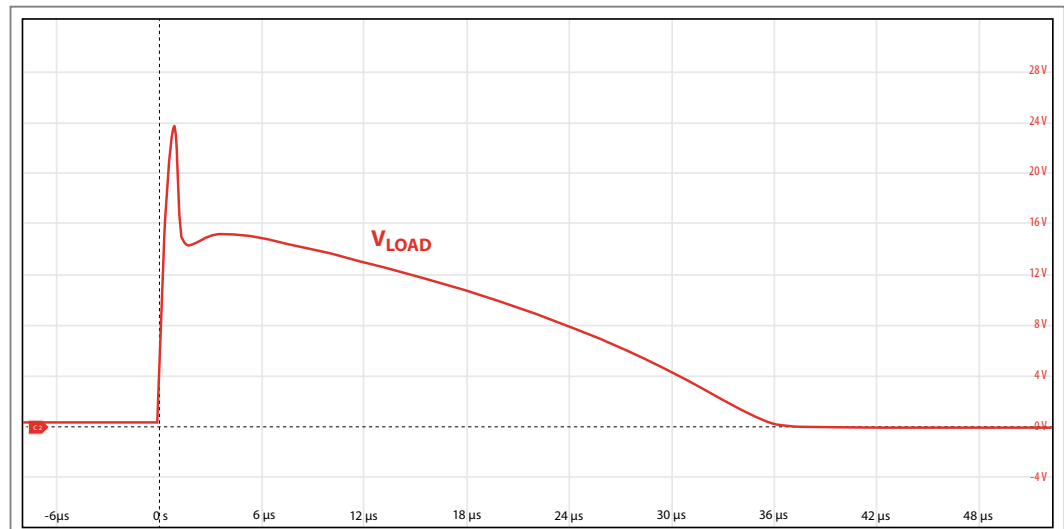

Figure 8 - Total Time of the TBU[®] Device Going Into Protected State

APPLICATION NOTE

Model TBU-CA Series - Modeling and Recovery Time Estimations



Model TBU-CA Series

BENCH TEST (CONTINUED)

In Figure 9, V_{SIGNAL} at the input of the TBU® device shows the same behavior as the simulation during recovery. Here, the total recovery time is less than 250 μs . This time is much faster than the SPICE simulation.

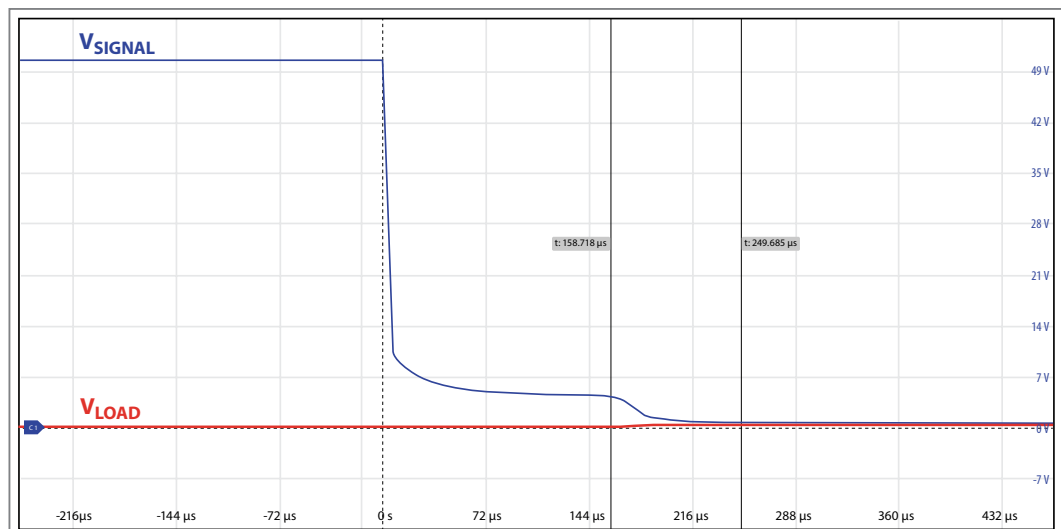

Figure 9 - TBU® Device Recovery at V_{SIGNAL}

APPLICATION NOTE

Model TBU-CA Series - Modeling and Recovery Time Estimations



Model TBU-CA Series

BENCH TEST (CONTINUED)

Figure 10 represents the behavior of the TBU® device at different signal voltage levels, during recovery time. Notice how, at $V_3 = 12\text{ V}$, the TBU® device's behavior changes, and at $V_3 \geq 15\text{ V}$, the TBU® device does not recover (above the V_{RESET}).

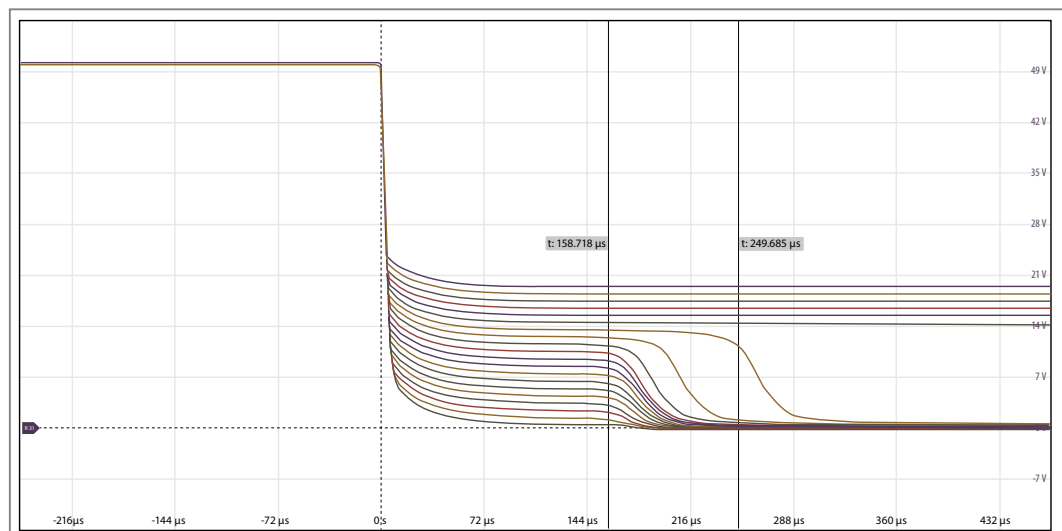

Figure 10 - Voltages Across the TBU® Device at Different Signal Levels, Actual

APPLICATION NOTE

Model TBU-CA Series - Modeling and Recovery Time Estimations



Model TBU-CA Series

SUMMARY

Based on the simulation bench testing, we've seen a difference in timing between both methods, although the behavior of the TBU® device SPICE model is still valid.

The TBU® device stays in a protected state approximately 160 μ s after the surge event. The ramp-down (going from protected to safe operating state) takes an additional 70 μ s to return to passive mode. The recommended time to allow the TBU® device to fully recover, while having a signal passing through, is approximately 250 μ s.

The effects of the current through the TBU® device and/or the signal's voltage level is minimal, but it is observed that the recovery time is not certain when the TBU® device is operating closer to its reset voltage.

www.bourns.com

BOURNS®

Americas: Tel +1-951 781-5500
Email americus@bourns.com

EMEA: Tel +36 88 885 877
Email eurocus@bourns.com

Asia-Pacific: Tel +886-2 256 241 17
Email asiacus@bourns.com

COPYRIGHT © 2019 • BOURNS, INC. • 03/19 - e/FU1901

"Bourns" and "TBU" are registered trademarks of Bourns, Inc. in the U.S. and other countries.