

APPLICATION BRIEF

Situation

Bourns High-Power Shunt Resistors are designed for precision current sensing in high-voltage applications. Built with automotive-grade components, they deliver the accuracy and reliability required in demanding environments – making them ideal for electric vehicle power-train vehicles. Accurate

current measurement is essential in Electric Vehicles (EV) for monitoring power dissipation, estimating driving range and ensuring passenger safety. Bourns High-Power Shunts are critical components for current sensing in high-voltage applications within the powertrain of an EV.

Solution

Current sensors rely on Ohm's Law ($I = V/R$) and the principles of voltmeter design to calculate the current running through the load. In an ammeter configuration, the sensor measures the voltage drop across a low-resistance shunt resistor, which is then isolated and processed to generate a digital representation of the current. These shunts are manufactured with high precision to ensure accurate and consistent current sensing. In high-voltage applications such as EV powertrains, reliability and durability are critical requirements. Bourns automotive-grade high-power shunts are specifically engineered to meet these demands, even under the most challenging conditions.

The figure illustrates the integration of a Bourns High-Power Shunt alongside other featured automotive parts. Designed with heavy-duty construction, the high-power shunt is optimized for direct use in high-voltage environments. Bourns' components play a central role in both the protection and operation of high-voltage current sensors, which are essential in systems such as the onboard charger, battery management system, and electric motor drive. Known for their reliability and performance, Bourns High-Power Shunts are trusted solutions suitable for a wide range of EV applications.

Figure Application

The figure illustrates a typical current sensor layout within an electric vehicle powertrain. A 48 V input is commonly used to minimize wire gauge and reduce heat generation, making it efficient for powering the auxiliary systems in the powertrain. This voltage is stepped down to 5V using a range of Bourns' components. Bourns High-Power Shunts generate a precise, low-voltage drop, ensuring minimal power loss and high measurement efficiency. The resulting digital output is safeguarded with high-speed protection devices that shield against noise, overvoltage, and overcurrent events, ensuring accurate and reliable performance.

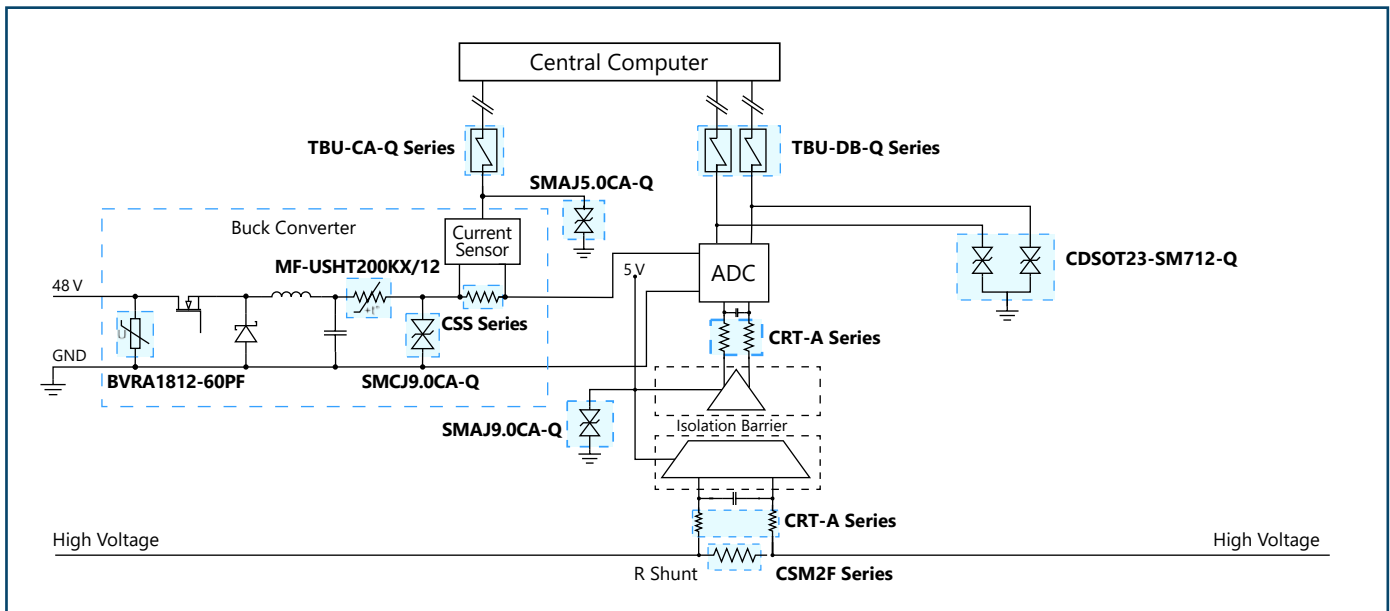

Benefits

- Bourns® Current Sensing Shunts deliver high accuracy and precision, providing high consumer satisfaction.
- Trusted by leading automotive manufacturers, Bourns' products are known for their reliability and quality.
- Bourns® Automotive-grade components comply with the latest AEC-Q200, AEC-Q101, or AEC-Q102 standards, ensuring performance and durability in demanding environments.





APPLICATION BRIEF



Overcurrent

Product Image	Device Type	Recommended Products	Specifications & Features
	PTC Resetttable Fuse	MF-USHT200KX/12	<ul style="list-style-type: none"> • Maximum Voltage: 6-60 VDC • Hold Current: 0.05-50 A • Operating Temperature: -40 to +125 °C
	TBU® HSP	TBU® High-Speed Protector (HSP)	<ul style="list-style-type: none"> • Max. Impulse Voltage: 250-850 V

Precision and Power

Product Image	Device Type	Recommended Products	Specifications & Features
	Current Sense Shunt	CSS , CSM2F	<ul style="list-style-type: none"> • Resistance Range: 0.2-5 mΩ • Tolerances: 1 %, 5 % • Power: 1.5-12 W
	Thin Film Precision Resistor	CRT-A	<ul style="list-style-type: none"> • Resistance Range: 0 Ω–100 MΩ • Tolerance: 0.1–5 % • Power: 0.05–3 W

Overvoltage

Product Image	Device Type	Recommended Products	Specifications & Features
	TVS Diode	SMAJ-Q Series , SMCJ-Q Series	<ul style="list-style-type: none"> • Min. Breakdown Voltage: 6.4-550 V • Power: 400-15000 W
	TVS Diode Array	CDSOT23-SM712-Q	<ul style="list-style-type: none"> • Min. Breakdown Voltage: 4- 26.2 V • Typical Capacitance: 5-500 pF
	Multilayered Varistor	BRVA1812-60PF	<ul style="list-style-type: none"> • Rated Voltage: 4–170 VDC • Surge Current Rating: 30–1200 A • Load Dump Energy: 1–50 J • Temperature Range: -55 to +150 °C