

Bourns Solution Picks: AI Datacenters

2026

For business enquiries, Please contact

Amol Joshi
Head of Marketing & Business Development,
Bourns Protection Division
Amol.Joshi@Bourns.com

BOURNS[®]



Bourns for Datacenters



Rapid Expansion of AI Workloads

The explosive growth of AI and machine learning is driving unprecedented demand for high-performance datacenters, pushing operators to rapidly scale compute density, power delivery, and thermal management while maintaining reliability and efficiency across increasingly complex infrastructure.



Power, Thermal, and Signal Integrity Challenges

As datacenters grow more compute-dense, operators must overcome rising power delivery demands, escalating heat generation, and tighter signal integrity requirements—all of which strain traditional architectures and call for advanced components, smarter protection strategies, and more efficient system-level design.



Bourns Expertise

With decades of leadership in circuit protection, power management, and precision components, Bourns delivers the reliability, efficiency, and performance needed to support today's high-density datacenter designs—helping operators meet growing AI-driven demands with robust, scalable solutions.

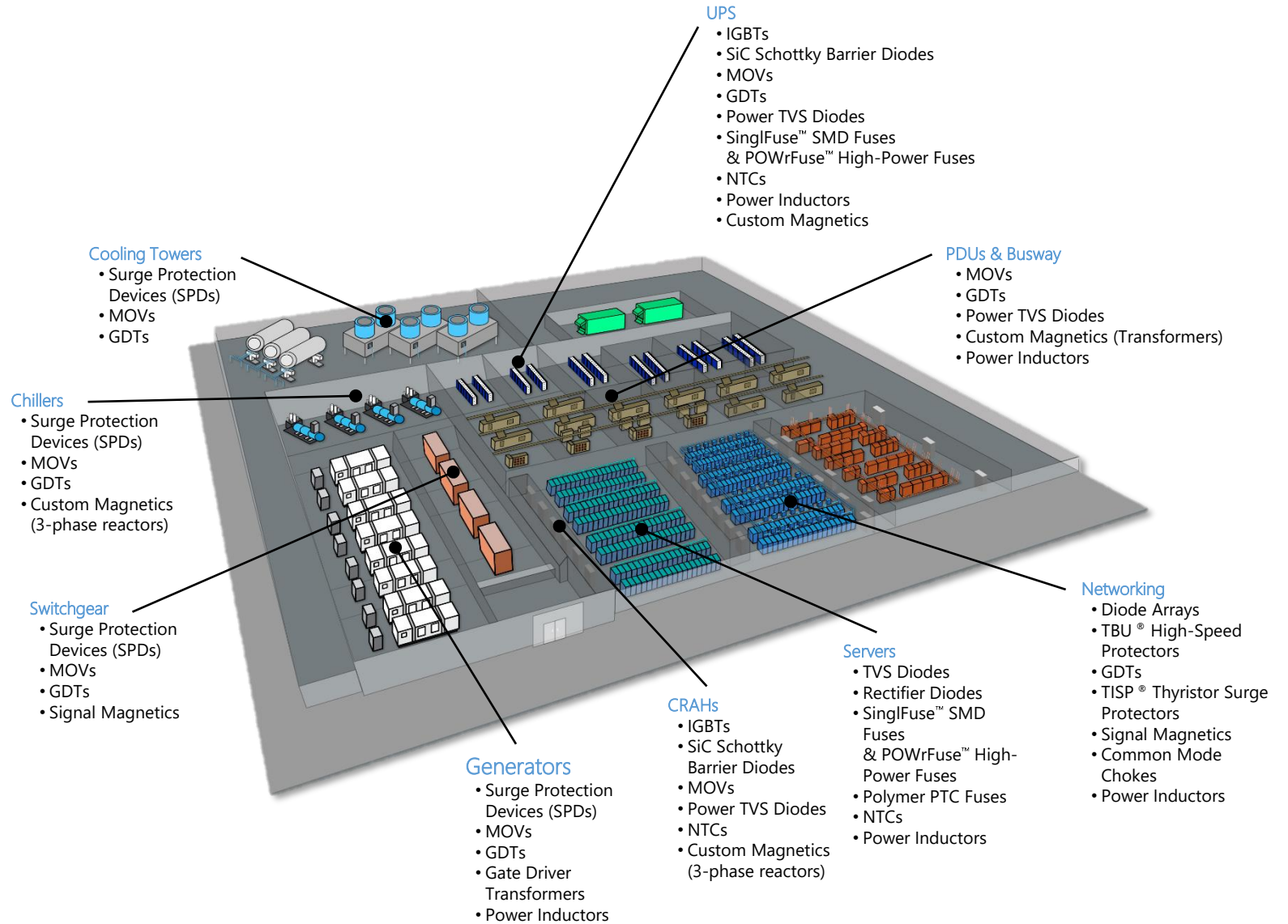

Powering Datacenters of the Future

The accelerating growth of compute-intensive AI and cloud workloads is driving unprecedented power demand within modern datacenters. As rack densities rise and facilities scale toward multi-megawatt deployments, operators face increasing pressure to deliver highly efficient, reliable, and scalable power architectures. Meeting these elevated power requirements demands advanced power conversion, robust distribution systems, and component solutions engineered to maintain performance under higher thermal and electrical stress.

Power Modules

Power modules are the building blocks of modern datacenter power systems, delivering compact, high-efficiency conversion and regulation designed to support rapidly increasing compute density while maintaining reliability and uptime.

12 – 50 VDC



3 – 5 kW



Power Shelves

Power shelves provide scalable, hot-swappable power distribution designed to keep servers running efficiently. By integrating multiple power modules in a unified platform, shelves ensure redundancy, streamlined maintenance, and consistent power delivery across high-load environments.

50 VDC



100 kW



Power Racks

Power racks anchor the electrical infrastructure of the datacenter, supplying coordinated, rack-level power management for dense server deployments. They enable flexible scaling, optimized energy use, and resilient operation as AI workloads push power demands to new levels.

±400/800
VDC



1 MW+



Our Extensive Portfolio

Bourns delivers a comprehensive portfolio of high-reliability components that strengthen datacenter power systems—from front-end rectification and power conversion to distribution and protection. With advanced power inductors, circuit protection, transformers, and sensing solutions, Bourns helps customers achieve higher efficiency, improved thermal performance, and robust system reliability across rapidly scaling AI and cloud infrastructures.

Inductors

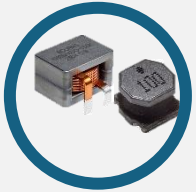

TVS Diodes



Fuses



Current Sense



Power Resistors



Sensors

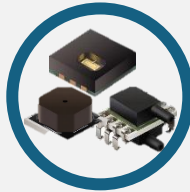

PPTCs

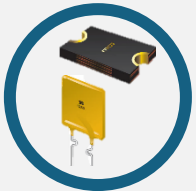

IGBTs/SiC Diodes

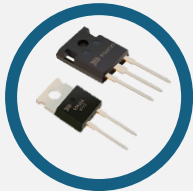

MOVs/GDTs/SPDs

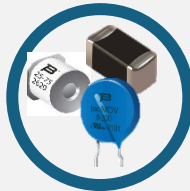

SMD Mini-Breakers



NTC Thermistors



Thermal Jumpers

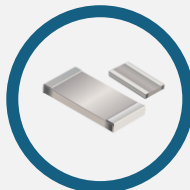

Application Focus

Hot Swap Applications

Rack Protection

Battery Backup Units

Capacitor Backup Units

Power Distribution Units (PDU)

CPU Vertical Power Delivery

CPU Lateral Power Delivery

Solid State Transformers (SST)

Memory

Networking

Battery Energy Storage Systems (BESS)

Traditional AC Rack

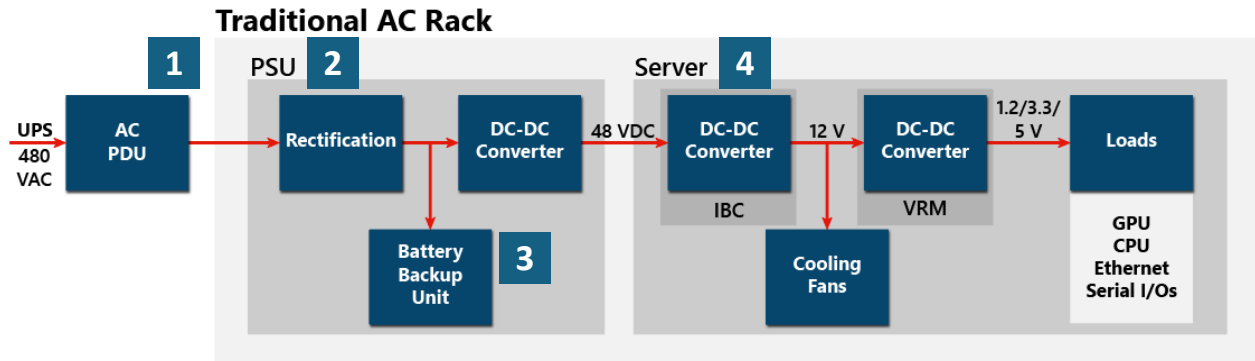

	Technology	Function	Product Series
1	Fuses	Input overcurrent protection	PF-63R50H , SF-3812TM-T
	Surge Protection, GDTs, MOVs, IsoMOV™ Hybrid Protectors	Input overvoltage protection	EV , IsoM , GDT25 , 1250A
	Current Sensing Shunts	Current sense for monitoring power consumption	CSI , CSS , CRK
	Flyback Transformers	AC-DC conversion	SM9104lxx
2	Power TVS Diodes	HVDC bus voltage protection	PTVS1-240C-M , PTVS3-430C-TH
	IGBTs	AC-DC power conversion and PFC topologies	BIDW75N65EH5
	Si/SiC Rectifier Diodes	High efficiency rectification for power conversion topologies	BSDH10G120E2 , CD1408-FF1xx
	Power Resistors	For energy dissipation circuits	PF2472 , PWR Wirewound
	Magnetics – Gate Drive	Driving power devices for precise switching	HVMA03
3	Fuses	Overcurrent protection for battery outputs	SF-2923HC-C , SF-2410F-T , PF-N
	TVS Diodes	Overvoltage protection for battery DC buses	SMA6J , PTVS2-xxxC-H
	Temperature Sensing Resistors	Temperature sensing for battery cells	RTDW
	Isolation Transformers, Power Inductors	Signal isolation in BMS Power conversion in DC-DC	SM918x , SM915x , Shielded Inductors
4	TVS Diodes, MLVs	Overvoltage protection for DC buses and hot-swap	ZV HT , SMF4C , 1120
	PTC Resettable Fuses	Resettable overcurrent protection	MF-USHT , MF-SMDF
	TBU® HSPs	Resettable overcurrent devices for communication buses	TBU-CA
	Thin- & Thick-film Chip Resistors	General purpose resistors for IC support	CRT1206A , CR
	TVS Diode Arrays	Overvoltage protection for communication buses	CDDFN10-0506N , CDSOT23-TxxLC
Magnetics	Power Inductors, TLV Inductors	Shielded Inductors TLVR1105	

*This table highlights the primary Bourns® components commonly used in each application segment; however, many of these products are versatile and may also be suitable for use in other sections depending on specific design requirements.

HVDC Sidecar Design

±400 & 800 VDC Sidecar

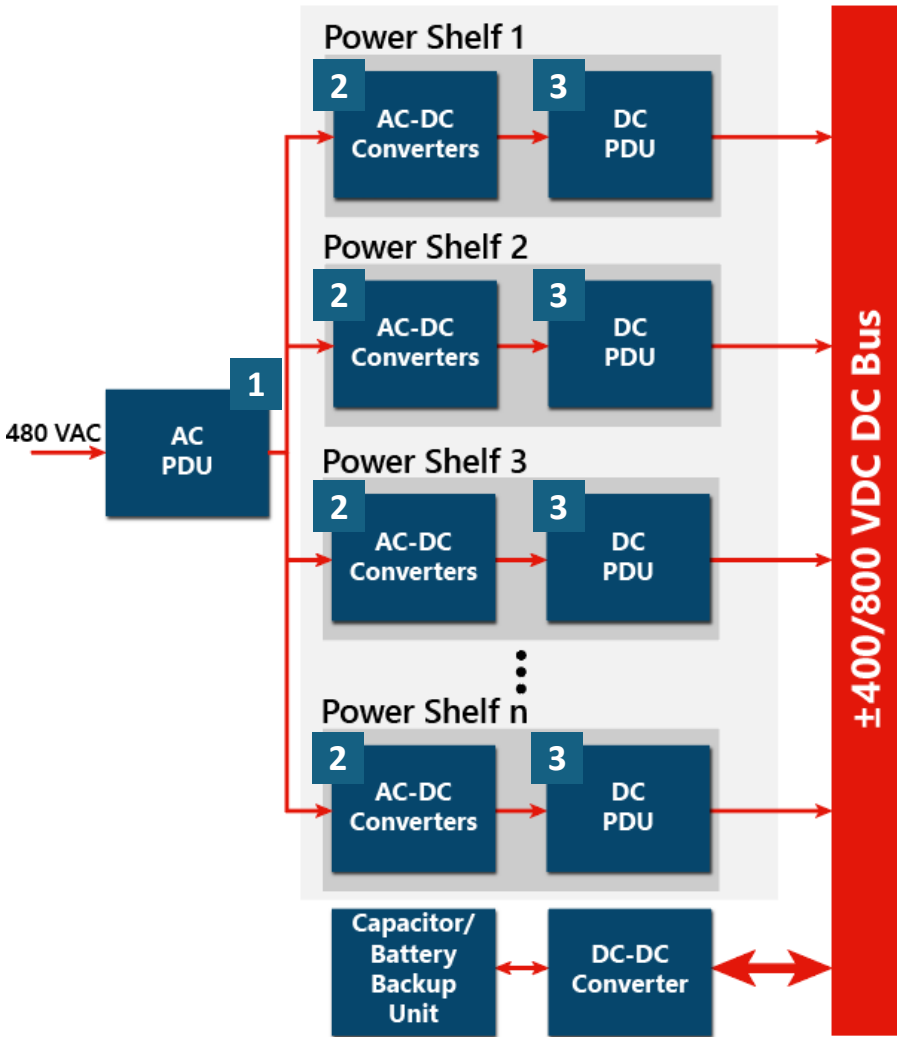

	Technology	Function	Product Series
1	Fuses	Input overcurrent protection	PF-63R50H , PF-F
	Surge Protection, GDTs, MOVs, IsoMOV™ Hybrid Protectors	Input AC overvoltage protection	EV , IsoM , GDT25 , 1280
	Current Sensing Shunts	Current sense for monitoring power consumption	CSM2F
	Common Mode Chokes	EMI - EMC	Q4770x
2	Power TVS Diodes	HVDC bus voltage protection	PTVS1-240C-M , PTVS3-430C-TH
	Surge Protection, GDTs, MOVs, IsoMOV™ Hybrid Protectors	Intermediate AC overvoltage protection	EV , IsoM , GDT25 , 1220
	IGBTs	AC-DC power conversion and PFC topologies	BIDW75N65EH5
	Si/SiC Rectifier Diodes	High efficiency rectification for power conversion topologies	BSDH10G120E2 , CD1408-FF1xx
	Power Resistors	For energy dissipation circuits	PF2472 , PWR Wirewound
3	Flyback Transformer	AC to DC conversion	SM9104lxx Custom Inductors
	Current Sensing Shunts	Current sense for monitoring power consumption	CSM2F
	Fuses	Output overcurrent protection	PF-63R50H , PF-F
	Power TVS Diodes	HVDC bus voltage protection	PTVS1-240C-M , PTVS3-430C-TH
	Custom Magnetics	Magnetics for isolated power	Custom Magnetics

*This table highlights the primary Bourns® components commonly used in each application segment; however, many of these products are versatile and may also be suitable for use in other sections depending on specific design requirements.

Traditional Enterprise Design with OCP Retrofit

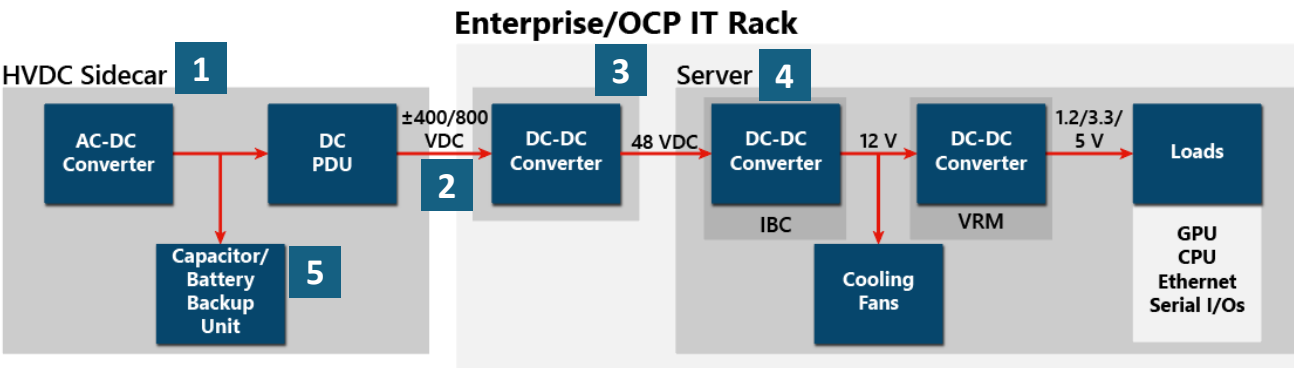

	Technology	Function	Product Series
1	*See HVDC Sidecar Design Slide*		
2	Fuses	HVDC bus overcurrent protection	PF-E, PF-63R50H
	Power TVS Diodes	HVDC bus voltage protection	PTVS1-240C-M, PTVS3-430C-TH
3	IGBTs	DC-DC power conversion topologies	BIDW75N65EH5
	Si/SiC Rectifier Diodes	High-efficiency rectification for power conversion topologies	BSDH10G120E2, CD1408-FF1xx
	Power Resistors	For energy dissipation circuits	PF2472, PWR Wirewound
	Power Inductors	Magnetics for power conversion	Planar Transformers, Custom Inductors
4	TVS Diodes, MLVs	Overvoltage protection for DC buses and hot-swap	ZV HT, SMF4C
	PTC Resettable Fuses	Resettable overcurrent protection	MF-USHT, MF-SMDF
	TBU®	Resettable overcurrent devices for communication buses	TBU-CA
	Thin- & Thick-Film Chip Resistors	General purpose resistors for IC support	CRT1206A, CR
	TVS Diode Arrays	Overvoltage protection for communication buses	CDDFN10-0506N, CDSOT23-TxxLC
	Power Inductors	Magnetics for power conversion	Shielded Inductors, Multiphase TLVR
5	Power Resistors, TFOS	For energy dissipation circuits like capacitive discharge	PF2472, PWR Wirewound, TFOS
	Fuses	Overcurrent protection for battery outputs	SF-2923HC-C, SF-2410F-T, PF-N
	TVS Diodes	Overvoltage protection for battery DC buses	SMA6J, PTVS2-xxxC-H
	Temperature Sensing Resistors	Temperature sensing for battery cells	RTDW
	Isolation Transformers, Gate Drive Transformers	BMS isolation, charge path gate drive	SM918x, SM915x, HVMA03

**This table highlights the primary Bourns® components commonly used in each application segment; however, many of these products are versatile and may also be suitable for use in other sections depending on specific design requirements.*

Next-Gen OCP Design

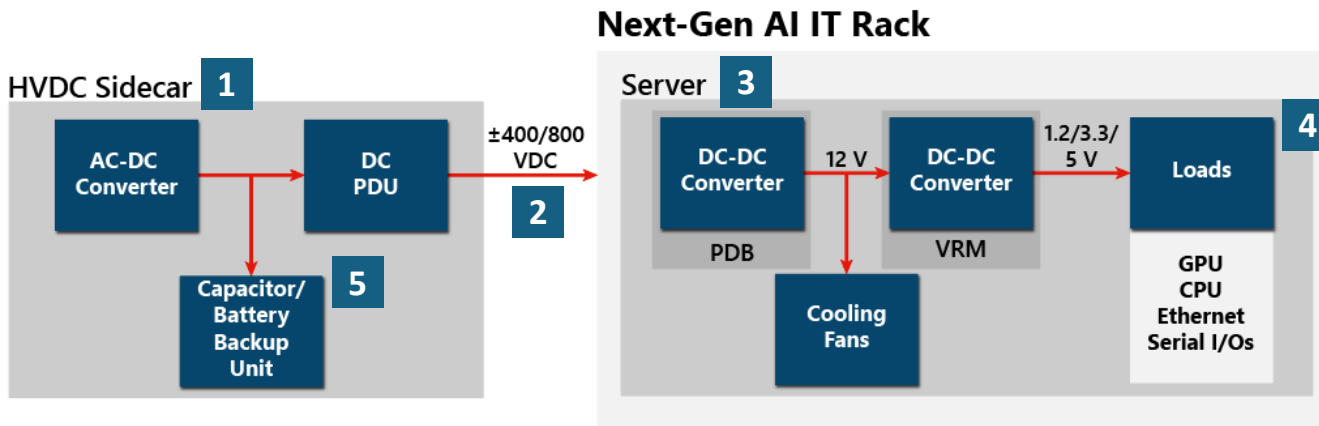

	Technology	Function	Product Series
1	*See HVDC Sidecar Design Slide*		
2	Fuses	HVDC bus overcurrent protection	PF-F , PF-63R50H
3	Power TVS Diodes	Hot-swap overvoltage protection	PTVS1-240C-M , PTVS3-430C-TH
	IGBTs	DC-DC Power conversion topologies	BIDW75N65EH5
	Si/SiC Rectifier Diodes	High efficiency rectification for power conversion topologies	BSDH10G120E2 , CD1408-FF1xx
	Power Resistors	For energy dissipation circuits	PF2472 , PWR Wirewound
	Power Inductor	Magnetics for power conversion	Planar Transformers , Custom Inductors
4	TVS Diodes, MLVs	Overvoltage protection for DC buses	ZV HT , SMF4C
	PTC Resettable Fuses	Resettable overcurrent protection	MF-USHT , MF-SMDF
	TBU®HSPs	Resettable overcurrent device for communication buses	TBU-CA
	Thin- & Thick-Film Chip Resistors	General purpose resistors for IC support	CRT1206A , CR
	TVS Diode Arrays	Overvoltage protection for communication buses	CDDFN10-0506N , CDSOT23-TxxLC
	Custom Magnetics	Dual & quad phase inductor	Multiphase TLVRs
	Power Resistors, TFOS	For energy dissipation circuits like capacitive discharge	PF2472 , PWR Wirewound , TFOS
5	Fuses	Overcurrent protection for battery outputs	SF-2923HC-C , SF-2410F-T , PF-N
	TVS Diodes	Overvoltage protection for battery DC buses	SMA6J , PTVS2-xxxC-H
	Temperature Sensing Resistors	Temperature sensing for battery cells	RTDW
	Isolation Transformers, Gate Drive Transformers	BMS isolation, charge path gate drive	SM918x , SM915x , HVMA03

**This table highlights the primary Bourns® components commonly used in each application segment; however, many of these products are versatile and may also be suitable for use in other sections depending on specific design requirements.*