



Revised Standards Provide Design Options for Primary and Secondary Protection

TELECOM PROTECTION WHITE PAPER

INTRODUCTION

Telecommunications networks are subject to surges from lightning or power line faults, and the effects of these can be extremely detrimental to systems and equipment. The equipment in a telecommunications network needs to be protected from fault voltages and currents induced onto the conductors. Standards provide equipment test requirements guidelines and often are separated into two main classifications: primary and secondary. Standards such as ITU-T and Telcordia GR-1089-CORE, Issue 6, contain tests in which equipment is tested with the primary protector in place. With vast differences distinguishing one telecommunication network from the next, standards provide a basis for equipment suppliers and customers alike to select the surge protection criteria that best suits their specific network application. The Alliance for Telecommunications Industry Solutions (ATIS) recently has updated its coordination document “Electrical Coordination of Primary and Secondary Surge Protection for Use in Telecommunications” (ATIS-0600338.2010) to aid in suitable design.

This paper discusses how to ensure system coordination by designing with various series coordination elements as presented in the updated ATIS document. Various system coordination styles and protection technology options will be presented with an emphasis on current-type coordination.



Revised Standards Provide Design Options for Primary and Secondary Protection

TYPES OF COORDINATION

There are three types of coordination covered in the ATIS-0600338.2010 document that can be considered in the design. First, with system coordination no failures occur to a predetermined fault level. In this arrangement, the primary protector external to the equipment can either operate or not operate.

Secondly, voltage-type coordination is where the primary protector operates before the secondary protection that is located in the equipment as shown in figure 1. The equipment will allow the primary protector voltage to be developed across its terminals without the secondary protector operating. Once the primary protector operates, it will shunt all the fault current away from the equipment.

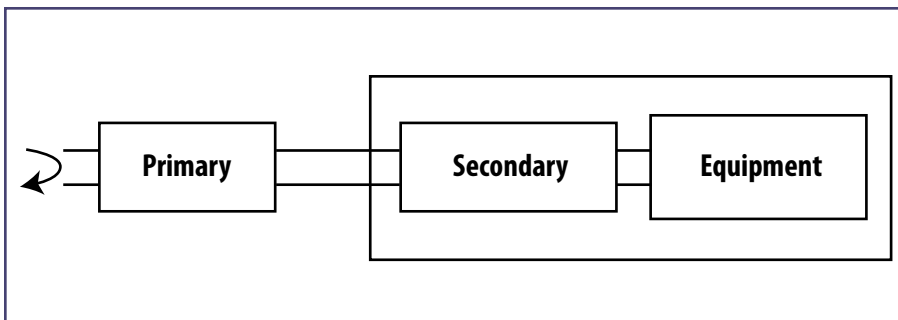

Figure 1. | Voltage-Type Coordination

Finally, current-type coordination is where the secondary protection at the equipment operates before the primary protector, as shown in figure 2. This type of coordination is commonly used. A coordination element is included to generate the primary protector operating voltage. Once this has been achieved, the primary protector will shunt away the majority of the fault current from the equipment. The protection in the equipment needs to support the fault voltage until the primary protector has operated.

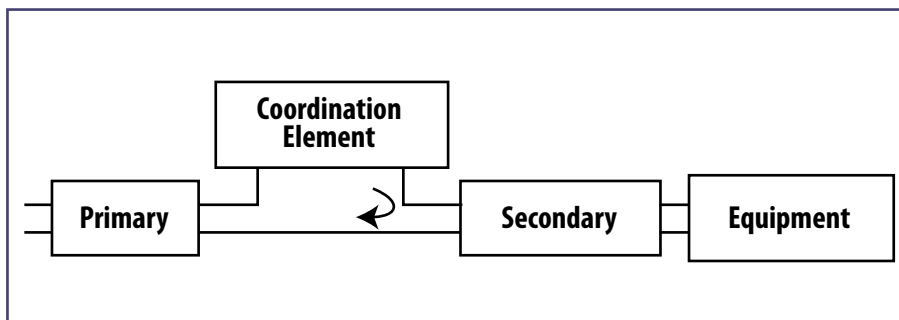

Figure 2. | Current-Type Coordination



Revised Standards Provide Design Options for Primary and Secondary Protection

TYPES OF PROTECTION

The primary and secondary protector each can be a switching device or a clamping device, which means four protection combinations are possible. For example, a gas discharge tube (GDT) primary protector is a switching device and a transient voltage suppressor (TVS) secondary protector is a clamping device. The opposite could be true with a clamping device as primary protector and a switching device such as a thyristor as the secondary protector. Finally, the primary and secondary protectors both can be clamping devices or both can be switching devices. ATIS-0600338.2010 covers all four combinations of technologies defined as primary and secondary protectors.

A typical telecom application is shown in figure 3 with a 5-pin protector and a typical line card layout. This solution makes use of switching devices as both the primary and secondary protection. The 5-pin in the main distribution frame (MDF) provides primary protection per GR-974-CORE. Secondary protection is designed per GR-1089-CORE and consists of two 1.25 A telecom fuses and suitably rated 100 A 10/1000 and 500 A 2/10 thyristors. The secondary protector ideally should match or exceed the fuse current ratings. In this example, the 1.25 A fuse is the series coordinating element.

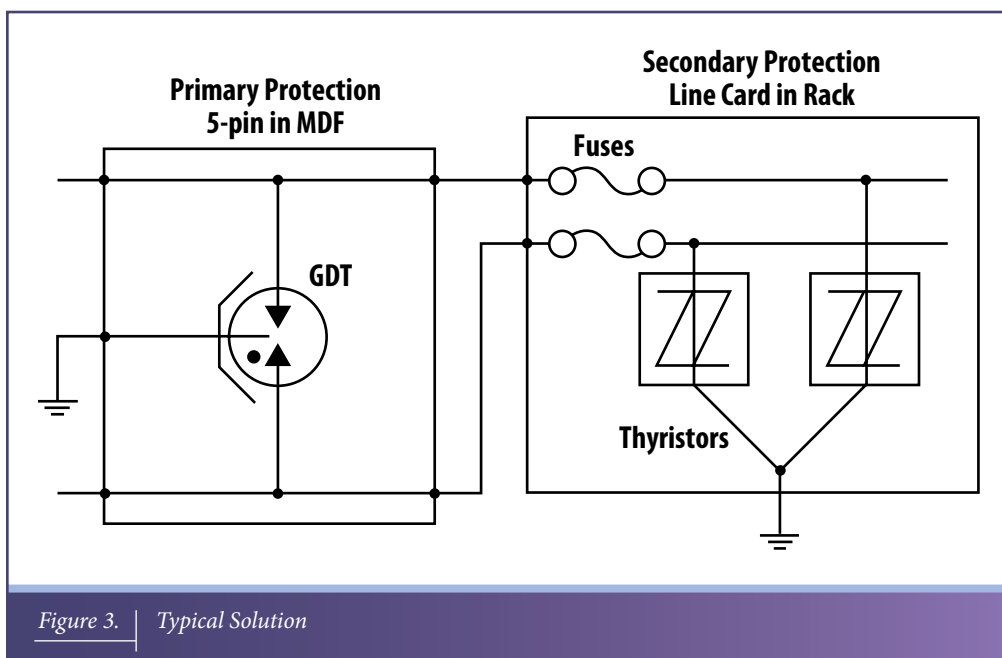

Figure 3. Typical Solution



Revised Standards Provide Design Options for Primary and Secondary Protection

THEORY OF CURRENT-TYPE COORDINATION

The interaction of components need to be considered as in figure 4, which shows various circuit elements in a current-type switching coordination. Analysis of this circuit aids in understanding how the various components involved in a protection solution work together when tested with a surge generator.

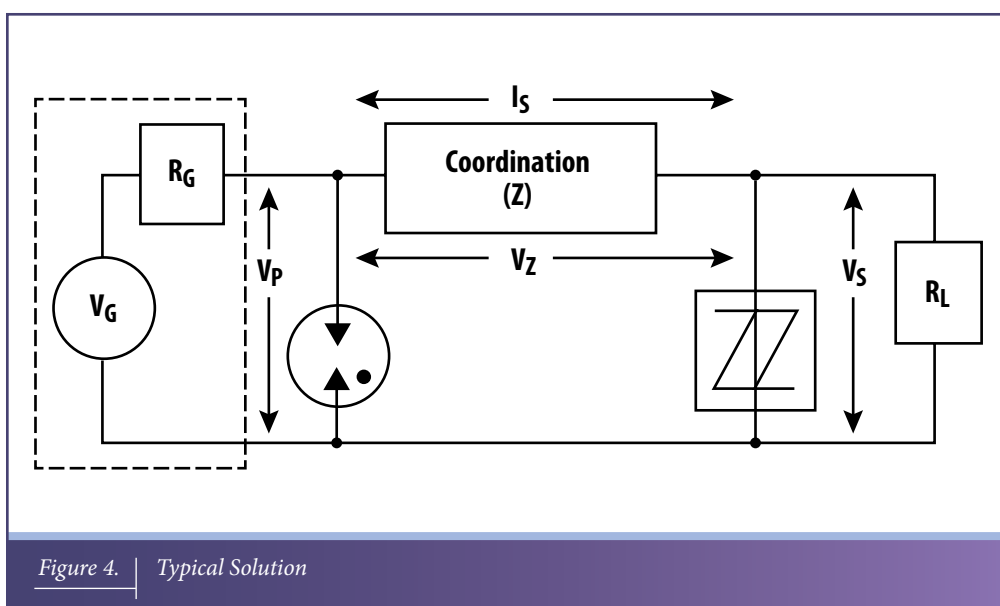

Figure 4 shows the test generator with voltage V_G and internal resistance R_G . The voltage V_S required to operate the secondary protector is developed across the load, R_L . The primary protector operating voltage is defined as V_P and the voltage developed across the coordination element is identified as V_Z . The current through the coordination element is I_S . Since this application uses a crowbar type device for the secondary protector, V_Z will be approximately equal to V_P when this operates.



Revised Standards Provide Design Options for Primary and Secondary Protection

THEORY OF CURRENT-TYPE COORDINATION (*Continued*)

From figure 4, if no overvoltage protection elements operate during the test, the level of voltage stress seen by the load, R_L , is established where V_S will be:

$$V_S = V_G \left[R_L + \frac{Z + R_G}{R_L + Z + R_G} \right]$$

The voltage, V_G , to which the test generator must be set to cause the secondary protector to operate is defined as:

$$V_O = V_S \left[1 + \frac{Z + R_O}{R_L} \right]$$

The secondary protection voltage, V_S , is the maximal dynamic breakover voltage, $V_{(BO)}$, of the thyristor, for example. For secondary thyristor protection such as the Bourns® TISP4CxxxH3BJR series, a good rule of thumb is to add 15-20 % to the data sheet $V_{(BO)}$ specification if the impulse breakover is not specified and to take into account extended ambient temperatures.

When the secondary protector has operated and in a virtual short, the voltage generated across the coordination element, V_Z , will be approximately equal to the primary protecting voltage, V_P :

$$V_Z \sim V_P = V_G \left[\frac{Z}{Z + R_G} \right]$$

Changing this formula around will define what the peak generator voltage has to be in order to make the primary protector operate.

$$V_O = V_P \left[1 + \frac{R_O}{Z} \right]$$

The voltage across the primary protector that is necessary in order to make it operate must be known. The primary protector is often a GDT. If the primary protection is activated during the impulse, then the minimal impedance for the coordination element is calculated as:

$$Z_{(MLA)} = R_G \left[\frac{V_P}{V_G - V_P} \right]$$

Understanding how the primary protection behaves is an important aspect of the protection design. If the primary voltage is not activated then the secondary protection will need to support the following current for the duration of the fault event:

$$I_S = \left[\frac{V_G}{R_G + Z} \right]$$

In this case the secondary protection must be capable of withstanding the full current of the surge as though the primary protection was not present.



Revised Standards Provide Design Options for Primary and Secondary Protection

SELECTING THE OPTIMAL COORDINATION ELEMENT, Z

The coordination element can be cable impedance or traditional components such as ceramic and polymer PTCs, electronic current limiters (ECLs), fuses, and line feed resistors (LFRs). With cable coordination, the longitudinal time delay relies on the cable having a propagation speed of 9 ns/m (18 ns/m return). It has been established that a cable length of 100 ft (30 m) or more normally is required to ensure surge coordination.

Polymer PTC (PPTC) thermistors increase in resistance with an increase in ambient temperature. PPTC resistance normally does not change during a surge, and therefore the PPTC minimum resistance can be used for the coordination impedance. PPTC thermistors are chosen based on the temperature, resistance, and time to trip.

Ceramic PTCs (CPTCs), on the other hand, will see their resistance reduce as ambient temperature increases. The lowest resistance typically can be around 85 °C before entering the trip point, above which the resistance increases exponentially. The CPTC resistance also will decrease by 70 % or more during a surge, depending on the CPTC and the surge applied to it. The graph below shows a 55 Ω CPTC looking like 16 Ω, where the secondary overvoltage protector current needs to be considered.

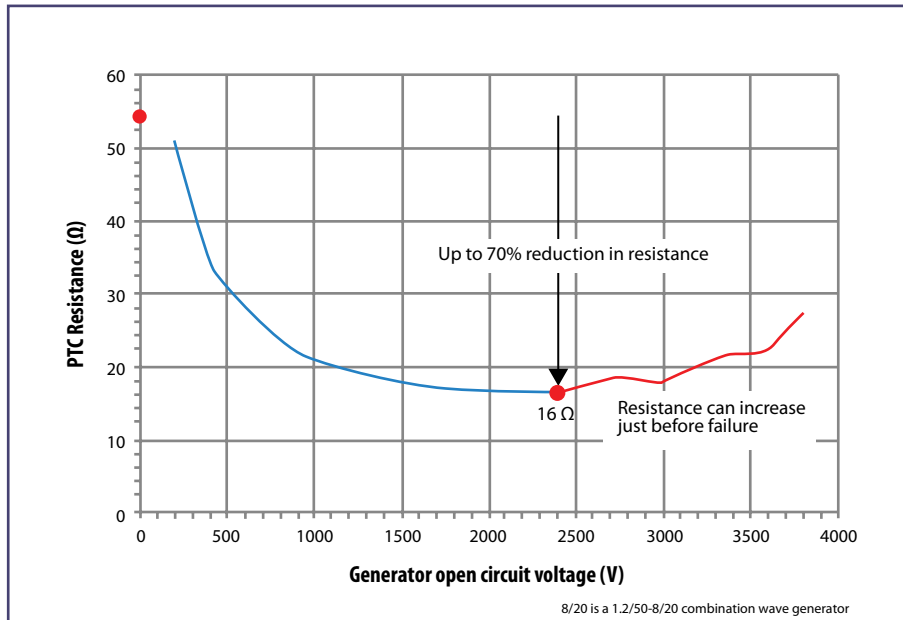

Figure 5. | CMF-RL55-0-A1 Resistance During 8/20 μs
Generator Resistance = 2 Ω



Revised Standards Provide Design Options for Primary and Secondary Protection

SELECTING THE OPTIMAL COORDINATION ELEMENT, Z (Continued)

CPTC thermistors need to consider the minimum resistance for impedance coordination calculation. The key factors are also the maximal voltage across the CPTC during a surge and the time between surges.

Bourns® TBU® High-Speed Protectors (HSPs) are an optimal electronic current limiter-based solution for POTS or dry-line data interfaces such as VDSL2 that need capacitance coupling coordination. Bourns® TBU® HSPs quickly react to surges to provide a high impedance interface that helps to ensure coordination while also limiting the let-through current to the secondary overvoltage protector. Because of their high impedance in its tripped state, TBU® HSPs must be limited to the data sheet maximum, as illustrated in the figure below using the Bourns® TBU-CA-085-500-WH as an example.

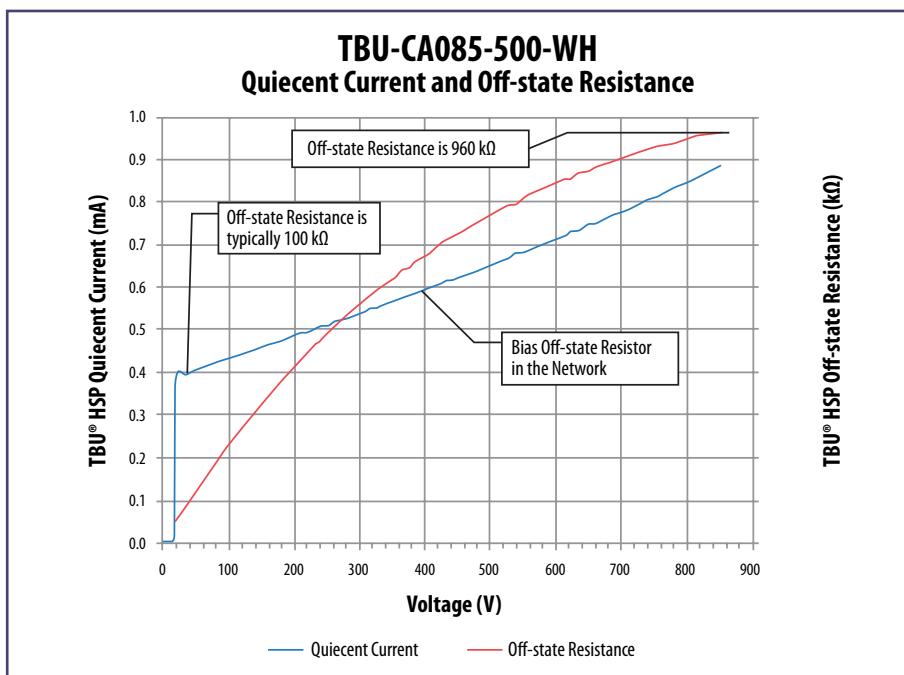

Figure 6. TBU® HSP tripped resistance is ~ 100 kΩ. No blind spots in the current-type coordination

LFRs are made of a ceramic substrate with the resistor inked onto its surface. They are designed specifically to withstand surge. The LFR can provide a tight ratio-matched tolerance of 1 %, and 0.2 % is possible. Due to its construction an LFR also has an exceptional resistance versus temperature characteristic, where a change of just 6 mΩ/°C is possible. AC protection commonly is done with a thermal link fuse on the ceramic. It will open should the ceramic substrate temperature increase due to power being dissipated in the resistance.



Revised Standards Provide Design Options for Primary and Secondary Protection

DEFINING THE PRIMARY PROTECTOR OPERATING VOLTAGE, V_p

To address the numerous environments in which telecommunications protection must operate, three voltage levels are specified in GR-974-CORE. This aids in selecting the appropriate technology for the protection solution. High voltage limiting protects to 1000 V and typically includes just a GDT. Medium voltage limiting includes a hybrid GDT that incorporates a voltage clamp such as a metal oxide varistor (MOV) that provides a maximal peak voltage of 600 V. A low voltage limiting category with 400 V maximum addresses solid state technology found in thyristor primary protectors. The AC limit is defined as $425 V_{rms}$ for all of these types of category primary protectors.

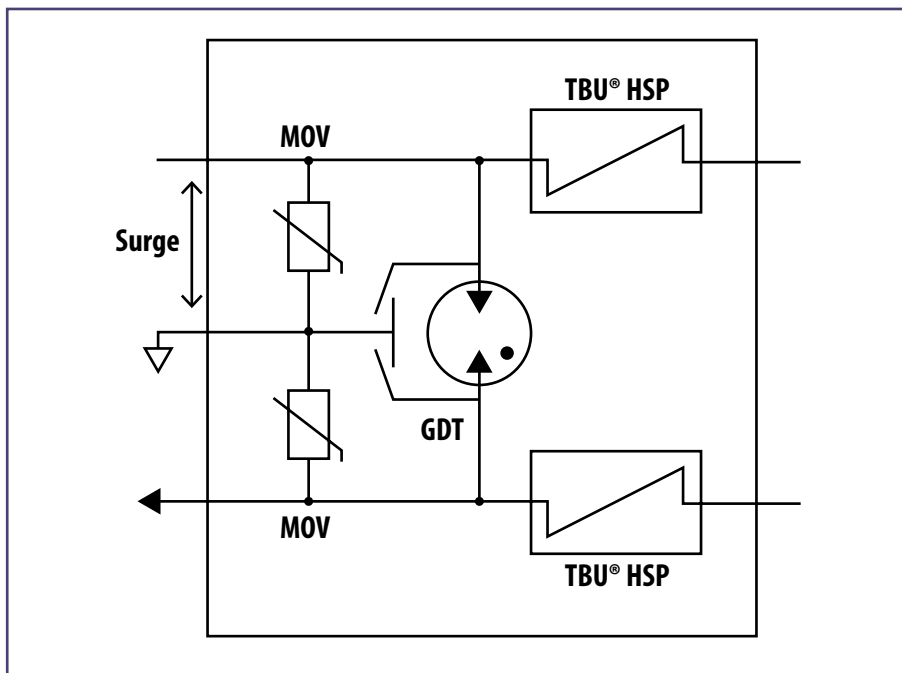

Figure 7. | Hybrid Primary and Secondary Protector



Revised Standards Provide Design Options for Primary and Secondary Protection

BOURNS BENEFITS

Bourns is a long-time leader in providing proven circuit protection solutions. With products aligned with industry standards, Bourns' technology is available to meet the needs of an ATIS standards-driven design. Products based on the hybrid 5-pins are just one example of Bourns' mature technology that can be used to meet the most recent revision of the standards. Evaluating a circuit for primary and secondary protection becomes an easier process with these new hybrid options. Bourns is committed to superior customer service and offers extensive engineering expertise.

ADDITIONAL RESOURCES

For more information about Bourns' complete line of circuit protection solutions for telecommunications applications, please visit:

www.bourns.com

COPYRIGHT© 2011 • BOURNS, INC. • 7/11 e/CPK1124

"Bourns" and "TBU" are registered trademarks of Bourns, Inc. in the U.S. and other countries.

BOURNS®

7/11 • e/CPK1124

Americas: Tel +1-951 781-5500
Fax +1-951 781-5700

EMEA: Tel +41-(0)41 768 55 55
Fax +41-(0)41 768 55 10

Asia-Pacific: Tel +886-2 256 241 17
Fax +886-2 256 241 16