

TISP4600F3, TISP4700F3 HIGH VOLTAGE BIDIRECTIONAL THYRISTOR OVERVOLTAGE PROTECTORS

TISP4600F3, TISP4700F3

**Ion-Implanted Breakdown Region
Precise and Stable Voltage
Low Voltage Overshoot under Surge**

Device	V _{DRM} V	V _(BO) V
'4600	420	600
'4700	500	700

Rated for International Surge Wave Shapes

Wave Shape	Standard	I _{TSP} A
2/10	GR-1089-CORE	190
8/20	IEC 61000-4-5	175
10/160	FCC Part 68	110
10/700	FCC Part 68 ITU-T K.20/21	70
10/560	FCC Part 68	50
10/1000	GR-1089-CORE	45

UL Recognized Component

Description

These devices are designed to limit overvoltages between a system and the protective ground. The TISP4700F3 is designed for insulation protection of systems such as LANs, and allows a float voltage of 500 V without clipping. IEC 60950 and UL 1950 have certain requirements for incoming lines of telephone network voltage (TNV). Any protector from the line to ground must have a voltage rating of 1.6 times the equipment rated voltage. International and European equipment usually have maximum rated voltages of 230 V rms, 240 V rms or 250 V rms. Multiplying the 250 V value by 1.6 gives a protector V_{DRM} value of 400 V. Allowing for operation down to 0 °C gives a V_{DRM} value of 420 V at 25 °C. This need is met by the TISP4600F3.

The protector consists of a symmetrical voltage-triggered bidirectional thyristor. Overvoltages are initially clipped by breakdown clamping until the voltage rises to the breakover level, which causes the device to crowbar into a low-voltage on state. This low-voltage on state causes the current resulting from the overvoltage to be safely diverted through the device. The high crowbar holding current helps prevent d.c. latching as the diverted current subsides. A single device provides 2-point protection. Combinations of devices can be used for multi-point protection (e.g. 3-point protection between Ring, Tip and Ground).

The TISP4x00F3 is guaranteed to voltage limit and withstand the listed international lightning surges in both polarities. This protection device is in a DO-92 (LM) cylindrical plastic package.

How To Order

Device	Package	Carrier	Order As
TISP4x00F3	LM, Straight Lead DO-92	Bulk Pack	TISP4x00F3LM-S
TISP4x00F3	LM, Straight Lead DO-92	Tape And Reel	TISP4x00F3LMR-S
TISP4x00F3	LMF, Formed Lead DO-92	Tape And Reel	TISP4x00F3LMFR-S

Insert x = 6 for TISP4600F3 and x= 7 for TISP4700F3

LM Package (Top View)

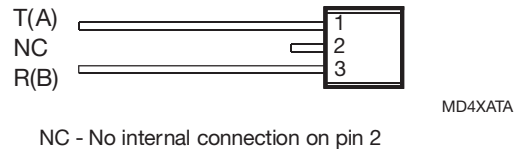

LMF Package (LM Pkg. with Formed Leads) (Top View)

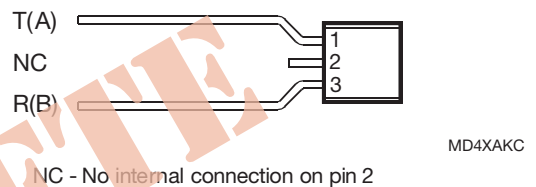

Device Symbol



Terminals T and R correspond to the alternative line designators of A and B

Absolute Maximum Ratings, $T_A = 25\text{ }^\circ\text{C}$ (Unless Otherwise Noted)

Rating	Symbol	Value	Unit
Repetitive peak off-state voltage	TISP4600F3 TISP4700F3	± 420 ± 500	V
Non-repetitive peak on-state pulse current (see Notes 1 and 2)	I_{PPSM}	190	A
2/10 (Telcordia GR-1089-CORE, 2/10 voltage wave shape)		100	
1/20 (ITU-T K.22, 1.2/50 voltage wave shape, 25 Ω resistor)		175	
8/20 (IEC 61000-4-5, combination wave generator, 1.2/50 voltage wave shape)		110	
10/160 (FCC Part 68, 10/160 voltage wave shape)		95	
4/250 (ITU-T K.20/21, 10/700 voltage wave shape, simultaneous)		70	
5/310 (ITU-T K.20/21, 10/700 voltage wave shape, single)		70	
5/320 (FCC Part 68, 9/720 voltage wave shape, single)		50	
10/560 (FCC Part 68, 10/560 voltage wave shape)		45	
10/1000 (Telcordia GR-1089-CORE, 10/1000 voltage wave shape)			
Non-repetitive peak on-state current (see Notes 1 and 2)	I_{TSM}	6	A
50/60 Hz, 1 s			
Initial rate of rise of on-state current, Linear current ramp, Maximum ramp value < 38 A	di_T/dt	250	A/ μ s
Junction temperature	T_J	-40 to +150	$^\circ\text{C}$
Storage temperature range	T_{stg}	-65 to +150	$^\circ\text{C}$

NOTES: 1. Initially, the TISP must be in thermal equilibrium with $T_J = 25\text{ }^\circ\text{C}$.

2. These non-repetitive rated currents are peak values of either polarity. The surge may be repeated after the TISP returns to its initial conditions.

Recommended Operating Conditions

Component	Min	Typ	Max	Unit
Series resistor for GR-1089-CORE first-level surge survival	15			Ω
Series resistor for ITU-T recommendation K.20 and K.21	0			
Series resistor for FCC Part 68 9/720 survival	0			
Series resistor for FCC Part 68 10/160, 10/560 survival	10			

Electrical Characteristics, $T_A = 25\text{ }^\circ\text{C}$ (Unless Otherwise Noted)

Parameter	Test Conditions	Min	Typ	Max	Unit
I_{DRM} Repetitive peak off-state current	$V_D = \pm V_{DRM}$			± 5	μA
$V_{(BO)}$ Breakover voltage	$dv/dt = \pm 700\text{ V/ms}$, $R_{SOURCE} = 300\text{ }\Omega$			± 600 ± 700	V
$I_{(BO)}$ Breakover current	$dv/dt = \pm 700\text{ V/ms}$, $R_{SOURCE} = 300\text{ }\Omega$		± 0.1		A
I_H Holding current	$I_T = \pm 5\text{ A}$, $di/dt = \pm 30\text{ mA/ms}$	± 0.15			A
dv/dt Critical rate of rise of off-state voltage	Linear voltage ramp, Maximum ramp value < $0.85V_{DRM}$	± 5			kV/ μ s
I_D Off-state current	$V_D = \pm 50\text{ V}$			± 10	μA
C_{off} Off-state capacitance	$f = 100\text{ kHz}$, $V_d = 1\text{ V rms}$, $V_D = 0$, $f = 100\text{ kHz}$, $V_d = 1\text{ V rms}$, $V_D = -50\text{ V}$		44 11	74 20	pF

Thermal Characteristics

Parameter	Test Conditions	Min	Typ	Max	Unit
$R_{\theta JA}$ Junction to free air thermal resistance	EIA/JESD51-3 PCB, $I_T = I_{TSM(1000)}$, $T_A = 25\text{ }^\circ\text{C}$, (see Note 3)			120	$^\circ\text{C/W}$
	265 mm x 210 mm populated line card, 4-layer PCB, $I_T = I_{TSM(1000)}$, $T_A = 25\text{ }^\circ\text{C}$		57		

NOTE 3: EIA/JESD51-2 environment and PCB has standard footprint dimensions connected with 5 A rated printed wiring track widths.

Parameter Measurement Information

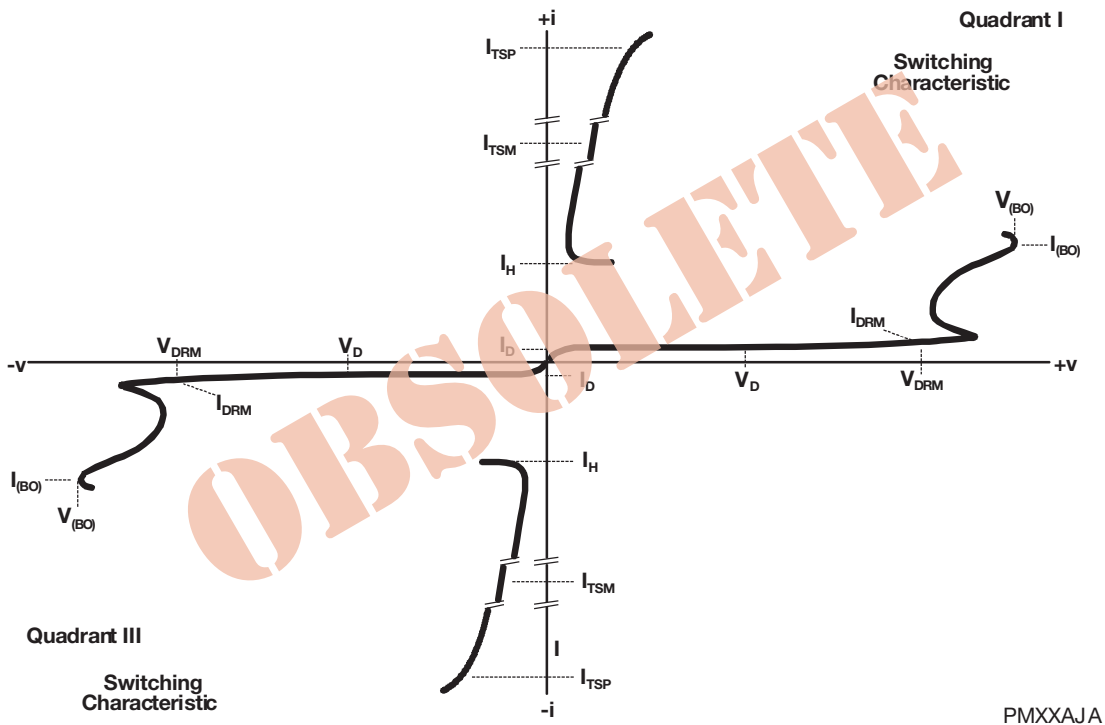

Figure 1. Voltage-Current Characteristic for R-T Terminal Pair

Typical Characteristics

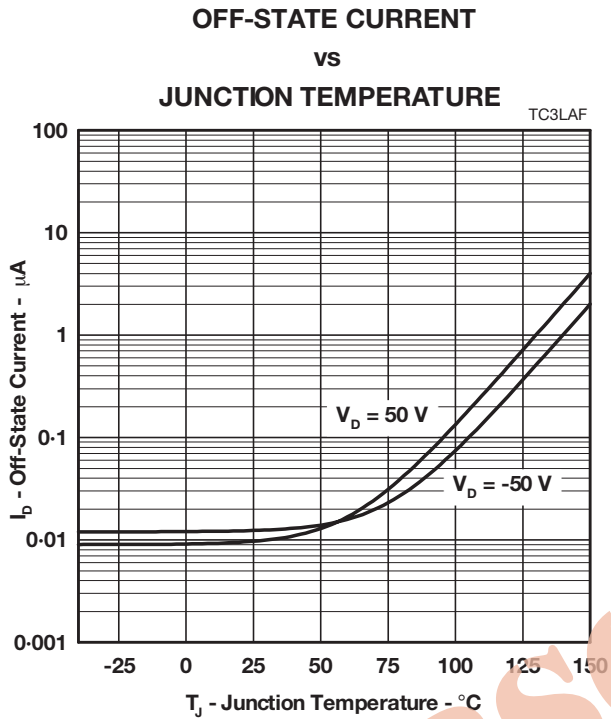

Figure 2.

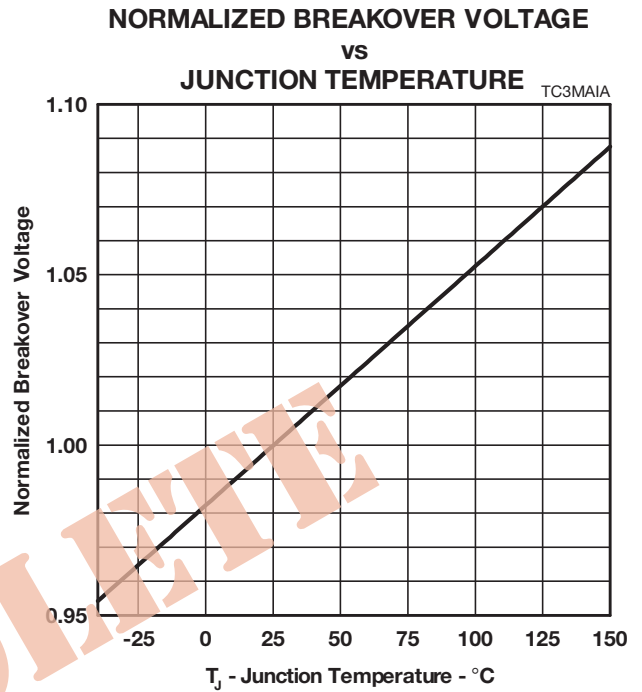

Figure 3.

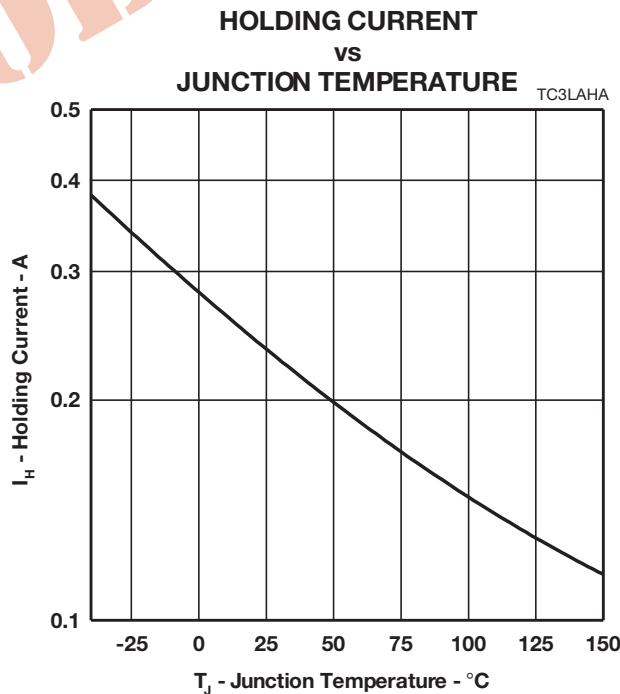

Figure 4.

Thermal Information

NON-REPETITIVE PEAK ON-STATE CURRENT
VS
CURRENT DURATION

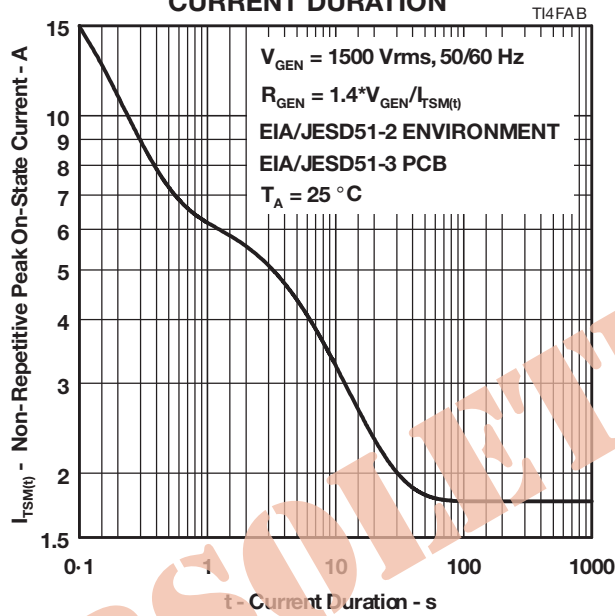

Figure 5.

APPLICATIONS INFORMATION

IEC 60950, EN 60950, UL 1950 and CSA 22.2 No.950

The '950 family of standards have certain requirements for equipment (EUT) with incoming lines of telecommunication network voltage (TNV). Any protector from a TNV conductor to protective ground must have a voltage rating of at least 1.6 times the equipment rated supply voltage (Figure 6). The intent is to prevent the possibility of the a.c. mains supply voltage from feeding into the telecommunication network and creating a safety hazard. International and European equipment usually have maximum rated voltages of 230 V rms, 240 V rms or 250 V rms. Multiplying the 250 V value by 1.6 gives a protector V_{DRM} value of 400 V. Allowing for operation down to 0 °C gives a V_{DRM} requirement of 420 V at 25 °C. This need is met by the TISP4600F3.

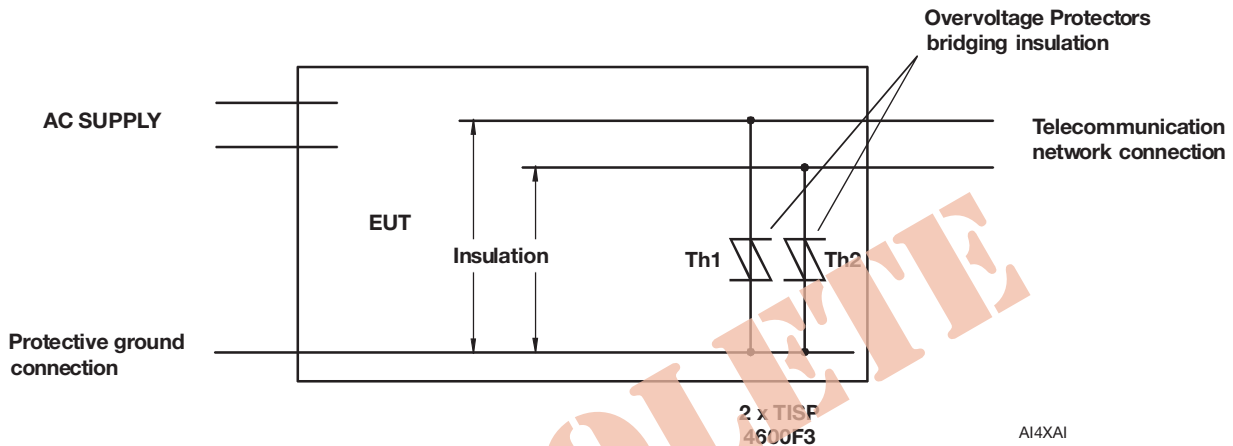

Figure 6. '950 TNV Network Insulation from Protective Ground

LAN Insulation Protection

In Figure 7, a low-voltage protector, Th1, from the TISP40xxL1 series limits the inter-conductor voltage of the LAN and the high-voltage protector, Th2, limits the insulation stress to 700 V. The four diode bridge, D1 through D4, reduces the capacitive loading of the protectors on the LAN and means that only one TISP4700F3 is needed to be used for insulation protection of both LAN conductors. Low voltage diodes can be used as the maximum reverse voltage stress is limited to the $V_{(BO)}$ value of the TISP40xxL1 protector plus the diode forward recovery voltage.

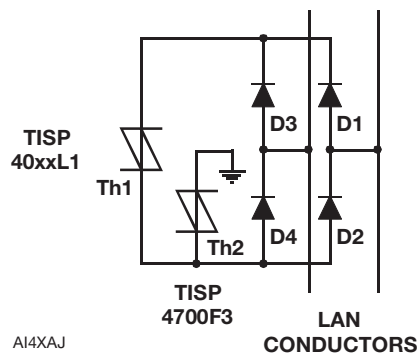

Figure 7. LAN Protection

MECHANICAL DATA**Device Symbolization Code**

Devices will be coded as follows:

Device	Symbolization Code
TISP4600F3	4600F3
TISP4700F3	4700F3

OBSOLETE

"TISP" is a trademark of Bourns, Ltd., a Bourns Company, and is Registered in U.S. Patent and Trademark Office.
"Bourns" is a registered trademark of Bourns, Inc. in the U.S. and other countries.

NOVEMBER 1997 - REVISED JANUARY 2010
Specifications are subject to change without notice.
Customers should verify actual device performance in their specific applications.