

TISP4125H3BJ & TISP4219H3BJ

Absolute Maximum Ratings, $T_A = 25\text{ °C}$ (Unless Otherwise Noted)

Rating	Symbol	Value	Unit
Repetitive peak off-state voltage, (see Note 1)	V_{DRM}	± 100 ± 180	V
Non-repetitive peak on-state pulse current (see Notes 2 and 3) 2/10 μs (GR-1089-CORE, 2/10 μs voltage wave shape) 8/20 μs (IEC 61000-4-5, 1.2/50 μs voltage, 8/20 current combination wave generator) 10/160 μs (FCC Part 68, 10/160 μs voltage wave shape) 5/200 μs (VDE 0433, 10/700 μs voltage wave shape) 0.2/310 μs (I3124, 0.5/700 μs voltage wave shape) 5/310 μs (ITU-T K.20/21, 10/700 μs voltage wave shape) 5/310 μs (FTZ R12, 10/700 μs voltage wave shape) 10/560 μs (FCC Part 68, 10/560 μs voltage wave shape) 10/1000 μs (GR-1089-CORE, 10/1000 μs voltage wave shape)	I_{TSP}	500 300 250 220 200 200 200 160 100	A
Non-repetitive peak on-state current (see Notes 2, 3 and 4) 20 ms (50 Hz) full sine wave 16.7 ms (60 Hz) full sine wave 1000 s 50 Hz/60 Hz a.c.	I_{TSM}	55 60 2.1	A
Initial rate of rise of on-state current, Exponential current ramp, Maximum ramp value < 200 A	di_T/dt	400	A/ μs
Junction temperature	T_J	-40 to +150	$^{\circ}C$
Storage temperature range	T_{stg}	-65 to +150	$^{\circ}C$

- NOTES: 1. See Applications Information for voltage values at lower temperatures.
 2. Initially, the TISP4xxxH3BJ must be in thermal equilibrium with $T_J = 25\text{ °C}$.
 3. The surge may be repeated after the TISP4xxxH3BJ returns to its initial conditions.
 4. EIA/JESD51-2 environment and EIA/JESD51-3 PCB with standard footprint dimensions connected with 5 A rated printed wiring track widths. See Figure 10 for the current ratings at other durations. Derate current values at $-0.61\%/^{\circ}C$ for ambient temperatures above 25 °C .

Recommended Operating Conditions

Component	Condition	Min	Typ	Max	Unit
R_S Series current limiting resistor	GR-1089-CORE first-level surge survival	0			Ω
	GR-1089-CORE first-level and second-level surge survival	0			Ω
	K.20, K.21 and K.45 coordination pass with a 400 V primary protector	6			Ω
V_{RING} AC ringing voltage	Figure 12, $V_{BAT} = -48\text{ V} \pm 2.5\text{ V}$, $R1 = R2 = 300\ \Omega$, $0\text{ °C} < T_A < +85\text{ °C}$	Battery-backed		87	V rms
		Ground-backed		101	V rms

Electrical Characteristics, TISP4xxxH3, T_A = 25 °C (Unless Otherwise Noted)

Parameter	Test Conditions	Min	Typ	Max	Unit
I _{DRM} Repetitive peak off-state current	V _D = V _{DRM} T _A = 25 °C T _A = 85 °C			±5 ±10	μA
V _(BO) Breakover voltage	dv/dt = ±250 V/ms, R _{SOURCE} = 300 Ω '4125 '4219			±125 ±219	V
V _(BO) Impulse breakover voltage	dv/dt ≤ ±1000 V/μs, Linear voltage ramp, Maximum ramp value = ±500 V di/dt = ±20 A/μs, Linear current ramp, Maximum ramp value = ±10 A '4125 '4219			±134 ±229	V
I _(BO) Breakover current	dv/dt = ±250 V/ms, R _{SOURCE} = 300 Ω	±0.15		±0.6	A
V _T On-state voltage	I _T = ±5 A, t _W = 100 μs			±3	V
I _H Holding current	I _T = ±5A, di/dt = +/-30 mA/ms	±0.15		± 0.6	A
dv/dt Critical rate of rise of off-state voltage	Linear voltage ramp, Maximum ramp value < 0.85V _{DRM}	±5			kV/μs
I _D Off-state current	V _D = ± 50 V T _A = 85 °C			±10	μA
C _{off} Off-state capacitance	f = 1 MHz, V _d = 1 V rms, V _D = 0, f = 1 MHz, V _d = 1 V rms, V _D = -1 V f = 1 MHz, V _d = 1 V rms, V _D = -2 V f = 1 MHz, V _d = 1 V rms, V _D = -50 V f = 1 MHz, V _d = 1 V rms, V _D = -100 V (see Note 5)		80 71 65 30 23	90 79 74 35 28	pF

NOTE 5: To avoid possible voltage clipping, the '4125 is tested with V_D = -98 V.

Thermal Characteristics

Parameter	Test Conditions	Min	Typ	Max	Unit
R _{θJA} Junction to free air thermal resistance	EIA/JESD51-3 PCB, I _T = I _{TSM(1000)} , T _A = 25 °C, (see Note 6)			113	°C/W
	265 mm x 210 mm populated line card, 4-layer PCB, I _T = I _{TSM(1000)} , T _A = 25 °C		50		

NOTE 6: EIA/JESD51-2 environment and the PCB has standard footprint dimensions connected with 5 A rated printed wiring track widths.

TISP4125M3BJ & TISP4219M3BJ

Absolute Maximum Ratings, $T_A = 25\text{ }^\circ\text{C}$ (Unless Otherwise Noted)

Rating	Symbol	Value	Unit
Repetitive peak off-state voltage, (see Note 7)	V_{DRM}	± 100	V
		± 180	
Non-repetitive peak on-state pulse current (see Notes 8 and 9)	I_{TSP}	300	A
2/10 μs (GR-1089-CORE, 2/10 μs voltage wave shape)		220	
8/20 μs (IEC 61000-4-5, 1.2/50 μs voltage, 8/20 current combination wave generator)		120	
10/160 μs (FCC Part 68, 10/160 μs voltage wave shape)		110	
5/200 μs (VDE 0433, 10/700 μs voltage wave shape)		100	
0.2/310 μs (I3124, 0.5/700 μs voltage wave shape)		100	
5/310 μs (ITU-T K.20/21, 10/700 μs voltage wave shape)		100	
5/310 μs (FTZ R12, 10/700 μs voltage wave shape)		75	
10/560 μs (FCC Part 68, 10/560 μs voltage wave shape)		50	
10/1000 μs (GR-1089-CORE, 10/1000 μs voltage wave shape)			
Non-repetitive peak on-state current (see Notes 8, 9 and 10)	I_{TSM}	30	A
20 ms (50 Hz) full sine wave		32	
16.7 ms (60 Hz) full sine wave		2.1	
1000 s 50 Hz/60 Hz a.c.			
Initial rate of rise of on-state current, Exponential current ramp, Maximum ramp value < 200 A	di_T/dt	300	A/ μs
Junction temperature	T_J	-40 to +150	$^\circ\text{C}$
Storage temperature range	T_{stg}	-65 to +150	$^\circ\text{C}$

- NOTES: 7. See Applications Information for voltage values at lower temperatures.
 8. Initially, the TISP4xxxM3BJ must be in thermal equilibrium with $T_J = 25\text{ }^\circ\text{C}$.
 9. The surge may be repeated after the TISP4xxxM3BJ returns to its initial conditions.
 10. EIA/JESD51-2 environment and EIA/JESD51-3 PCB with standard footprint dimensions connected with 5 A rated printed wiring track widths. See Figure 11 for the current ratings at other durations. Derate current values at $-0.61\text{ }^\circ\text{C}$ for ambient temperatures above $25\text{ }^\circ\text{C}$.

Recommended Operating Conditions

Component	Condition	Min	Typ	Max	Unit
R_S Series current limiting resistor	GR-1089-CORE first-level surge survival	10			Ω
	GR-1089-CORE first-level and second-level surge survival	12			Ω
	K.20, K.21 and K.45 coordination pass with a 400 V primary protector	6			Ω
V_{RING} AC ringing voltage	Figure 12, $V_{\text{BAT}} = -48\text{ V} \pm 2.5\text{ V}$, $R1 = R2 = 300\ \Omega$, $0\text{ }^\circ\text{C} < T_A < +85\text{ }^\circ\text{C}$	Battery-backed		87	V rms
		Ground-backed		101	V rms

Electrical Characteristics, TISP4xxxM3, T_A = 25 °C (Unless Otherwise Noted)

Parameter	Test Conditions	Min	Typ	Max	Unit
I _{DRM} Repetitive peak off-state current	V _D = V _{DRM} T _A = 25 °C T _A = 85 °C			±5 ±10	μA
V _(BO) Breakover voltage	dv/dt = ±250 V/ms, R _{SOURCE} = 300 Ω	'4125 '4219		±125 ±219	V
V _(BO) Impulse breakover voltage	dv/dt ≤ ±1000 V/s, Linear voltage ramp, Maximum ramp value = ±500 V di/dt = ±20 A/μs, Linear current ramp, Maximum ramp value = ±10 A	'4125 '4219		±132 ±226	V
I _(BO) Breakover current	dv/dt = ±250 V/ms, R _{SOURCE} = 300 Ω	±0.15		±0.6	A
V _T On-state voltage	I _T = ±5 A, t _W = 100 μs			±3	V
I _H Holding current	I _T = ±5A, di/dt = +/-30 mA/ms	±0.15		±0.6	A
dv/dt Critical rate of rise of off-state voltage	Linear voltage ramp, Maximum ramp value < 0.85V _{DRM}	±5			kV/μs
I _D Off-state current	V _D = ±50 V T _A = 85 °C			±10	μA
C _{off} Off-state capacitance	f = 1 MHz, V _d = 1 V rms V _D = 0, f = 1 MHz, V _d = 1 V rms V _D = -1 V f = 1 MHz, V _d = 1 V rms V _D = -2 V f = 1 MHz, V _d = 1 V rms V _D = -50 V f = 1 MHz, V _d = 1 V rms V _D = -100 V (see Note 11)		62 56 52 26 21	74 67 62 31 25	pF

NOTE 11: To avoid possible voltage clipping, the '4125 is tested with V_D = -98 V.

Thermal Characteristics

Parameter	Test Conditions	Min	Typ	Max	Unit
R _{θJA} Junction to free air thermal resistance	EIA/JESD51-3 PCB, I _T = I _{TSM(1000)} , T _A = 25 °C, (see Note 12)			115	°C/W
	265 mm x 210 mm populated line card, 4-layer PCB, I _T = I _{TSM(1000)} , T _A = 25 °C		52		

NOTE 12: EIA/JESD51-2 environment and the PCB has standard footprint dimensions connected with 5 A rated printed wiring track widths.

Parameter Measurement Information

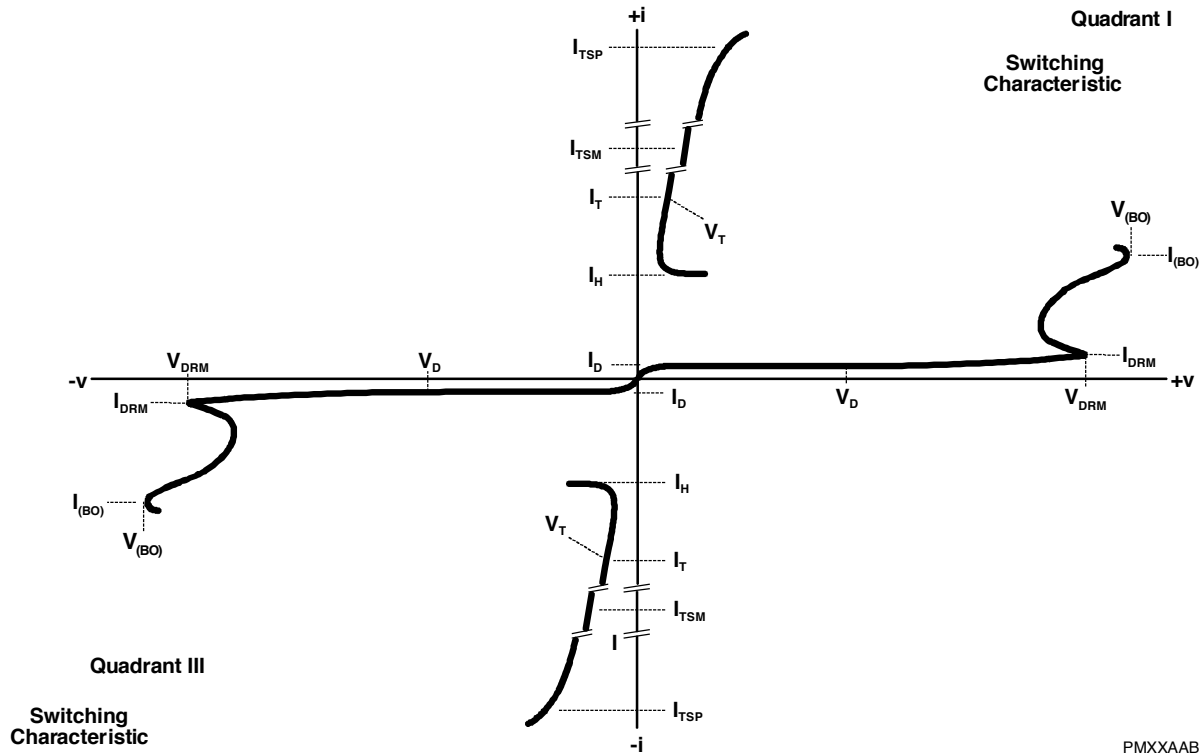

Figure 1. Voltage-Current Characteristic for T and R Terminals
All Measurements are Referenced to the R Terminal

TISP4xxxH3BJ Typical Characteristics

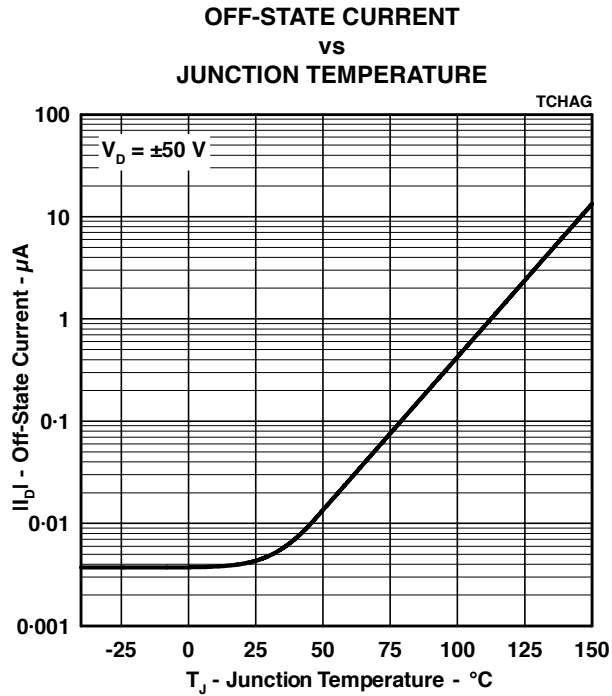

Figure 2.

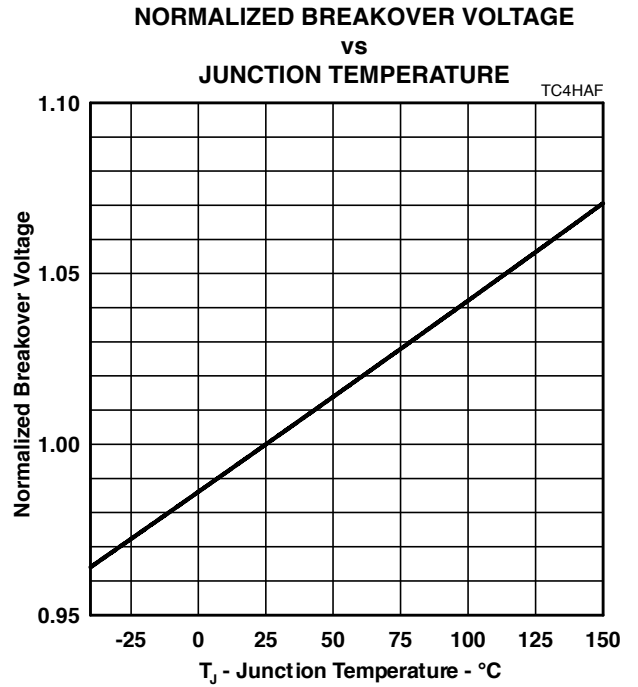

Figure 3.

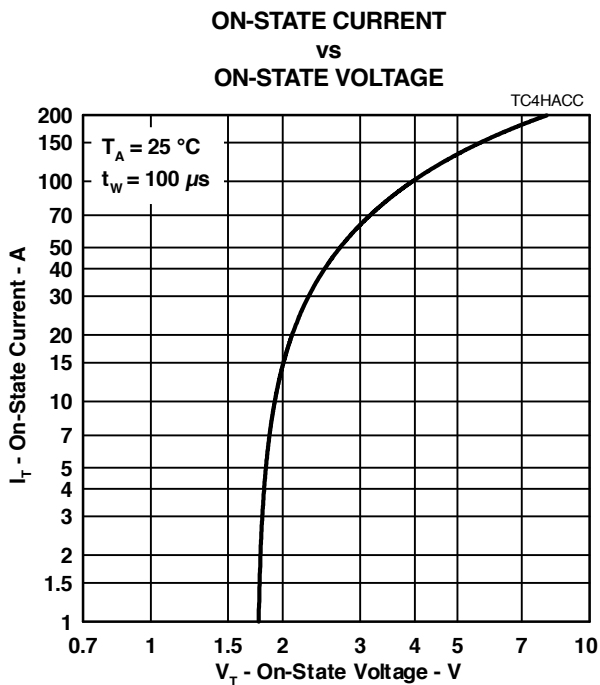

Figure 4.

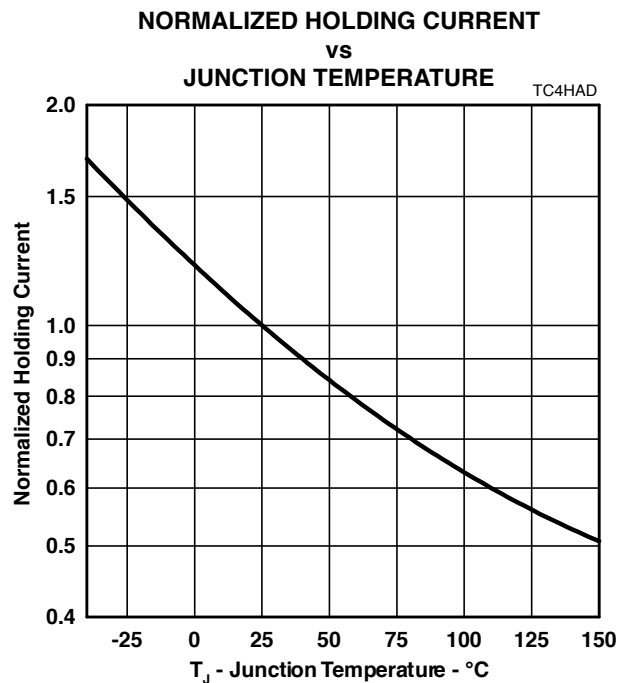

Figure 5.

JUNE 2001 – REVISED OCTOBER 2022

Specifications are subject to change without notice.

Users should verify actual device performance in their specific applications.

The products described herein and this document are subject to specific legal disclaimers as set forth on the last page of this document, and at www.bourns.com/docs/legal/disclaimer.pdf.

TISP4xxxM3BJ Typical Characteristics

**OFF-STATE CURRENT
vs
JUNCTION TEMPERATURE**

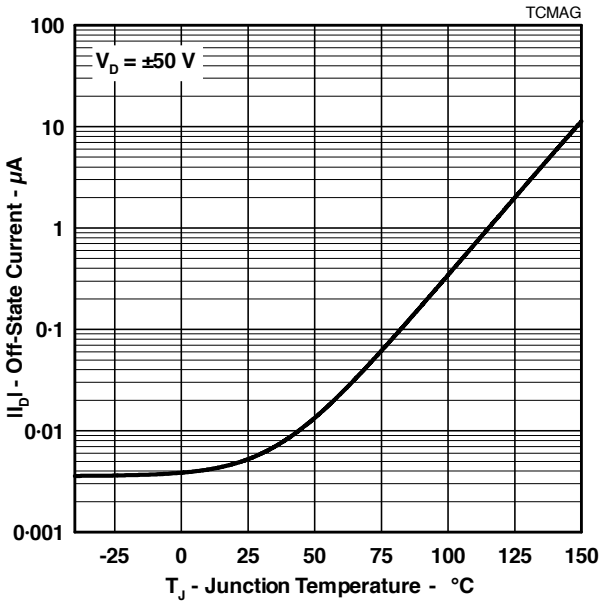

Figure 6.

**NORMALIZED BREAKOVER VOLTAGE
vs
JUNCTION TEMPERATURE**

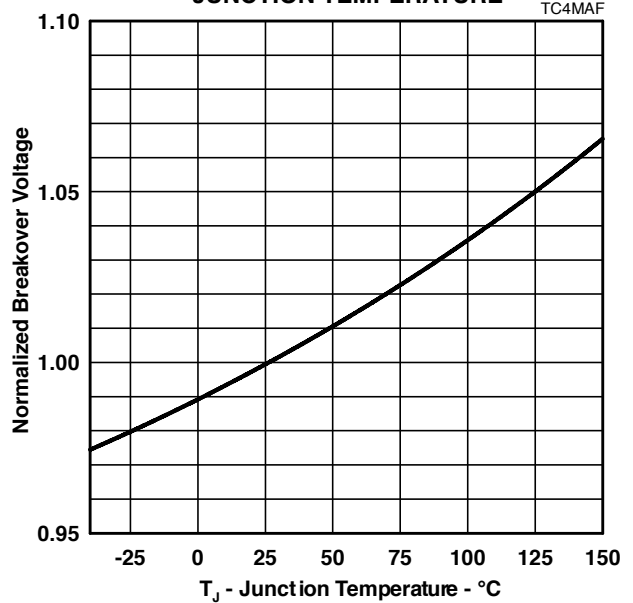

Figure 7.

**ON-STATE CURRENT
vs
ON-STATE VOLTAGE**

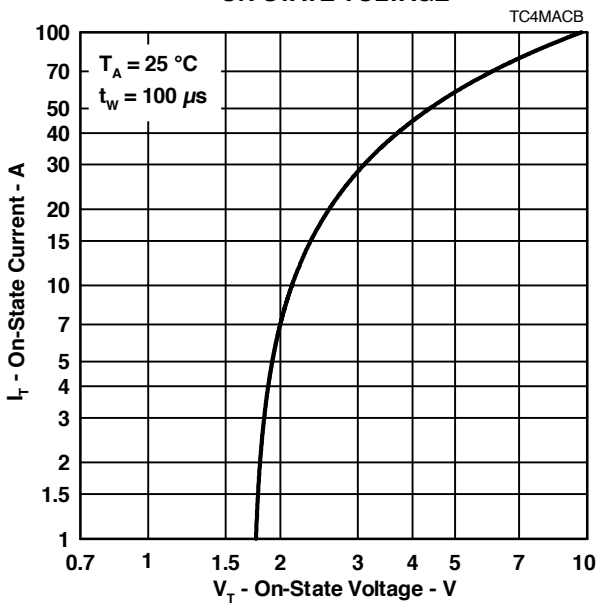

Figure 8.

**NORMALIZED HOLDING CURRENT
vs
JUNCTION TEMPERATURE**

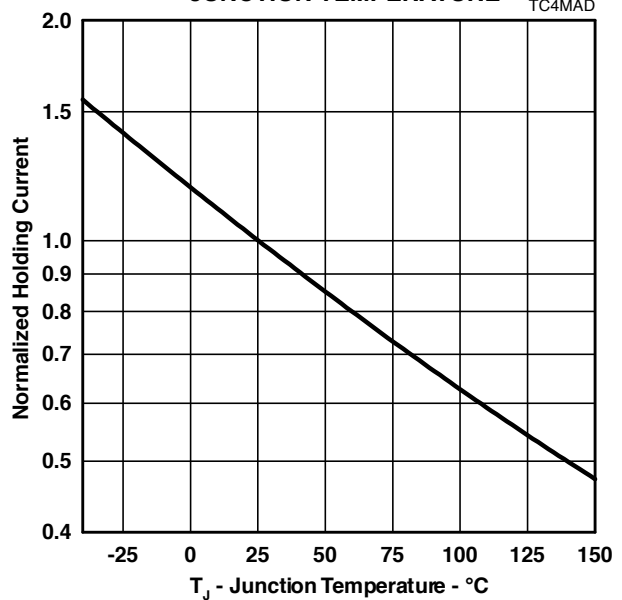

Figure 9.

Rating Information

TISP4xxxH3BJ

NON-REPETITIVE PEAK ON-STATE CURRENT
VS
CURRENT DURATION

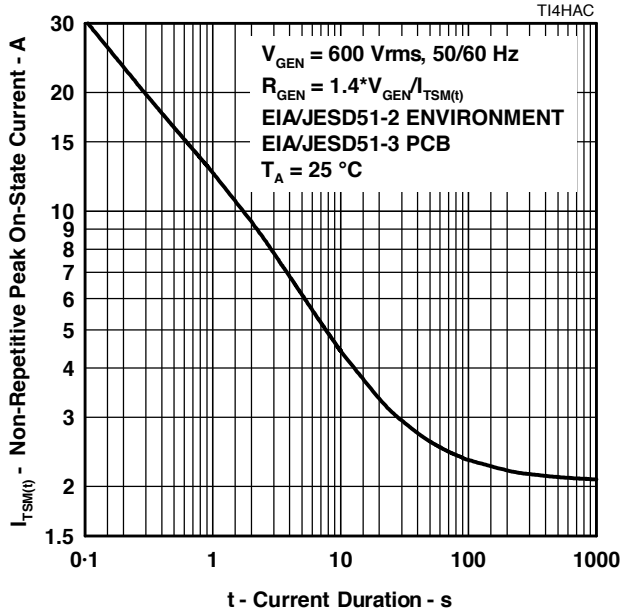

Figure 10.

TISP4xxxM3BJ

NON-REPETITIVE PEAK ON-STATE CURRENT
VS
CURRENT DURATION

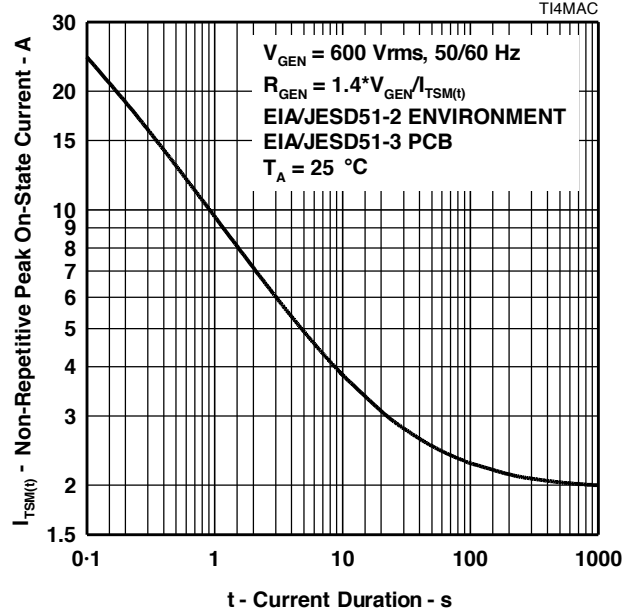

Figure 11.

APPLICATIONS INFORMATION

Introduction

These protector pairs have been designed to limit the peak voltages on the line terminals of '7581/7582/7583 LCAS (Line Card Access Switch) parts. An LCAS may also be referred to as a Solid-State Relay, SSR, i.e. a replacement of the conventional electro-mechanical relay.

The '7581 LCAS has two solid-state switches which connect the telephone line to the line card SLIC (Subscriber Line Interface Circuit), Figure 12, SW1 and SW2. A further two solid-state switches connect the telephone ringing generator to the line, Figure 12, SW3 and SW4. Applied 5-volt logic signals control the condition of the switches to perform the functions of line disconnect, connection to the SLIC and application of ringing. If excessive long-term overdissipation occurs, a thermal sensor activates thermal shutdown and opens the switches. The SLIC side of switches SW1 and SW2 is limited in voltage by internal protectors Th3 and Th4. The line-side of the LCAS is voltage limited by the two TISP® parts.

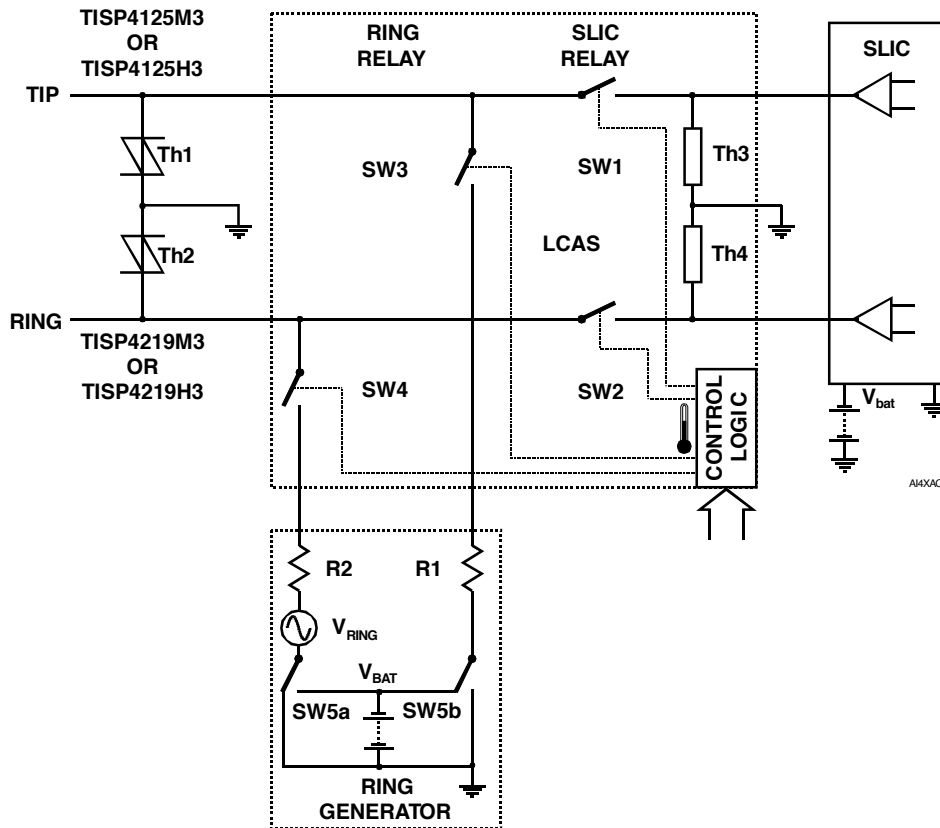

Figure 12. Basic LCAS Arrangement

Additional functions are provided by the '7582 (line test access) and the '7583 (test-in and test-out access). Up to three conventional electro-mechanical relays may be replaced by the LCAS. The resulting size reduction can double the line density of a line card.

This document covers the types of overvoltage protection required by the '7581 LCAS and how the TISP® part voltages are selected to provide these requirements. The LCAS '7582 and '7583 are also covered as the additional switches used in these parts are similar to the '7581.

LCAS Switch Ratings

When a switch is in the off state, the maximum withstand voltage may be set by the switch itself or by the control line to the switch. At 25 °C, the switch terminal to ground voltage rating for all the switches is ± 320 V. Switches SW1 to SW3 are bidirectional MOS types and can withstand ± 320 V between terminals. Switch SW4 is a bidirectional thyristor which is rated at ± 465 V between terminals.

Overcurrents as well as overvoltages occur on telephone lines. In the on state, the thyristor switch, SW4, is capable of withstanding high levels of current overload. For currents above about 200 mA, the MOS switches, SW1 to SW3, will go into a current limited condition. This will cause the voltage to rise across the switch and large amounts of power to be developed. In the longer term, this power loss increases the overall chip temperature. When the temperature exceeds about 125 °C, thermal shutdown occurs and the switches are set to the off state. Without power loss, the LCAS will cool. Eventually, the thermal trip will reset, setting the switches back in the high power loss condition again. The cycle of temperature increase, thermal shutdown, temperature decrease and switch re-activation will continue until the overcurrent ceases.

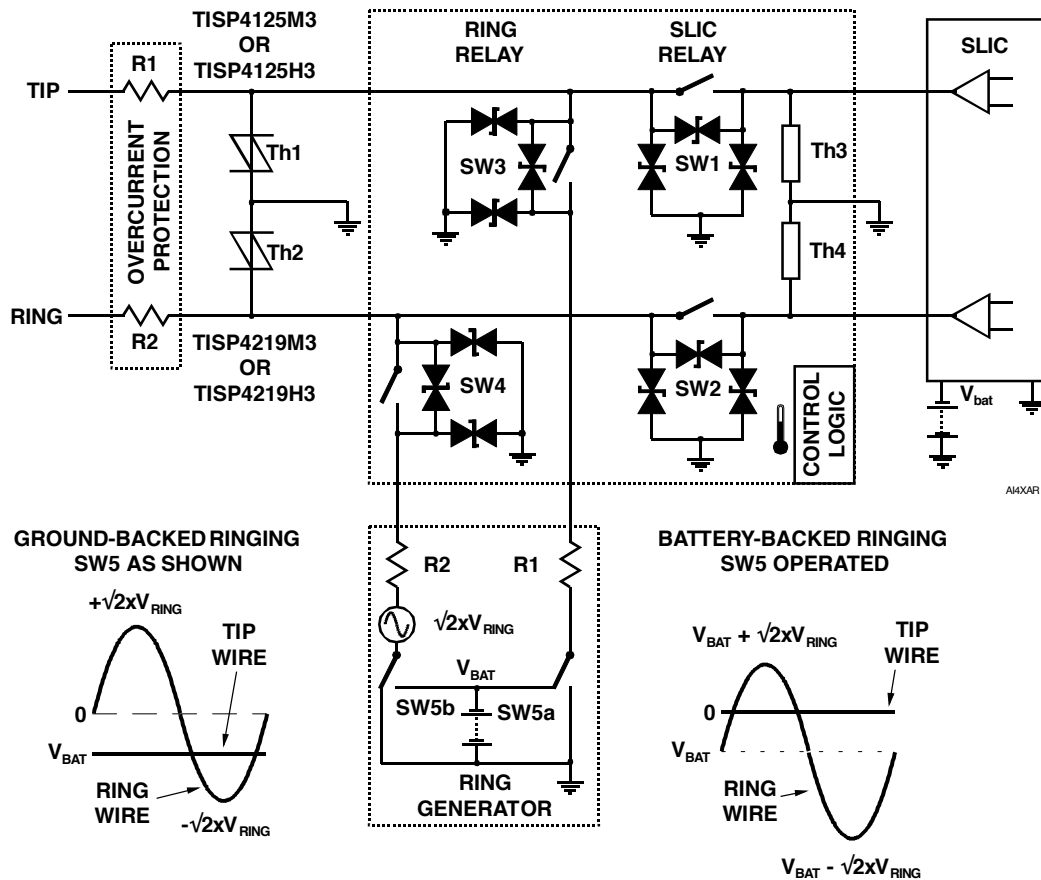

Figure 13. LCAS Shown with Switch Breakdown Limits

Equivalent Circuit

Figure 13 shows the LCAS switch voltage ratings as breakdown diodes, which must not be allowed to conduct. Each switch has three diodes; one between poles and the other two from each pole to ground. At 25 °C, switches SW1 through to SW3 have breakdown diode voltages of ± 320 V. Switch SW4 has breakdown diode voltage values of ± 465 V for the one between poles and ± 320 V for the two diodes connected to ground. Note that only protection to ground is required, as in the limit, the inter-switch voltage limitation of ± 640 V is the same as the switch to ground limitation of +320 V and -320 V in both polarities.

Protector Voltages

Protector working and protection voltage design calculations for the LCAS are described in the IEEE Std. C62.37.1-2000, **IEEE Guide for the Application of Thyristor Surge Protection Devices**, pp 40-43. These calculations comprehend:

- the temperature variation of LCAS voltage ratings,
- increase in protection voltage with ambient temperature rise, long term a.c. heating and under impulse conditions,
- decrease in working voltage with ambient temperature fall,
- ground-backed and battery-backed ringing configurations (see Figure 13).

These calculation techniques were used to set the TISP® part voltages. Using these TISP® parts allows normal system voltage levels of ± 100 V on TIP and ± 180 V on RING without clipping at 25 °C. At 0 °C ambient, these voltage levels become ± 97 V on TIP and ± 174 V on RING. Under open circuit line conditions, this means that the peak ringing voltage cannot exceed ± 174 V for equipment operation down to 0 °C ambient.

Assuming a battery voltage of 48 V ± 2.5 V and battery-backed ringing, the maximum peak a.c. ring voltage is $174 \text{ V} - 50.5 \text{ V} = 123.5 \text{ V}$ or 87 V rms. The working voltage of ± 97 V on TIP is more than half the ± 174 V working voltage on RING. As a result, the TIP working voltage does not represent a limitation for systems where the TIP return resistance is equal or less than the RING source resistance.

For balanced impedance ground-backed ringing, the maximum peak a.c. ring voltage under short line conditions (short between TIP and RING) is limited by the TIP working voltage of ± 97 V. In the negative ring polarity, the limit of the voltage is made up from half the battery voltage plus half of the peak a.c. ring voltage. The maximum peak a.c. ring voltage is $2 \times (97 - 50.5/2) = 143.5 \text{ V}$ or 101 V rms.

Line test voltage levels must be considered, whether they be applied by using LCAS switches or separate electro-mechanical relays. For these TISP® parts, the applied test voltage should not exceed the lowest working voltage, which is ± 97 V.

MECHANICAL DATA

Recommended Printed Wiring Footprint

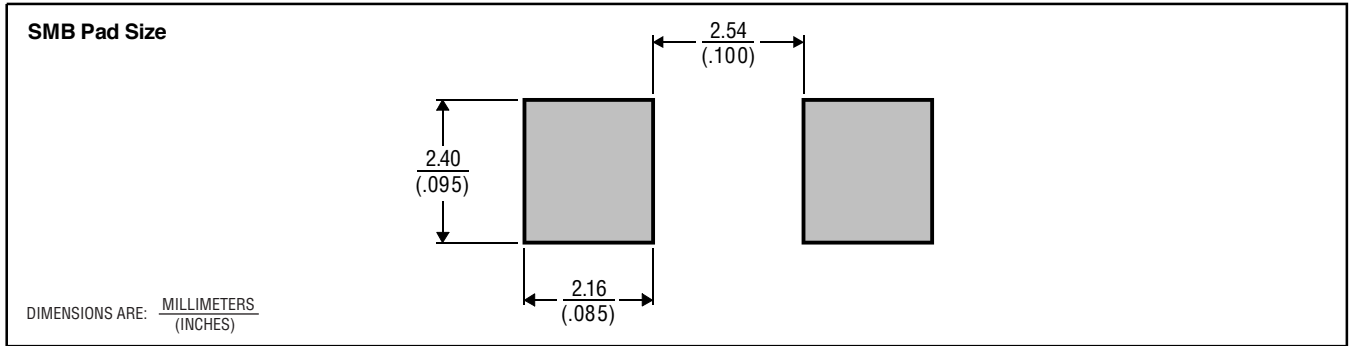

MDXXBIA

Device Symbolization Code

Devices will be coded as below. As the device parameters are symmetrical, terminal 1 is not identified.

Device	Symbolization Code
TISP4125H3BJ	4125H3
TISP4219H3BJ	4219H3
TISP4125M3BJ	4125M3
TISP4219M3BJ	4219M3

BOURNS®

Asia-Pacific: Tel: +886-2 2562-4117 • Email: asiacus@bourns.com

EMEA: Tel: +36 88 885 877 • Email: eurocus@bourns.com

The Americas: Tel: +1-951 781-5500 • Email: americus@bourns.com

www.bourns.com

"TISP" is a trademark of Bourns, Ltd., a Bourns Company, and is Registered in the U.S. Patent and Trademark Office. "Bourns" is a registered trademark of Bourns, Inc. in the U.S. and other countries.

JUNE 2001 – REVISED OCTOBER 2022

Specifications are subject to change without notice.

Users should verify actual device performance in their specific applications.

The products described herein and this document are subject to specific legal disclaimers as set forth on the last page of this document, and at www.bourns.com/docs/legal/disclaimer.pdf.

