



**TISP4125H3BJ/TISP4219H3BJ,  
TISP4125M3BJ/TISP4219M3BJ**

**LCAS RING AND TIP PROTECTION PAIRS  
BIDIRECTIONAL THYRISTOR OVERVOLTAGE PROTECTORS**

**TISP4xxxH3/M3BJ Series for LCAS Protection**

Customized Voltage for LCAS Protection  
Battery-Backed Ringing ..... 87 V rms  
Ground-Backed Ringing..... 101 V rms

Device	V <sub>DRM</sub> V	V <sub>(BO)</sub> V	LCAS TERMINAL
'4125	100	125	TIP
'4129	180	219	RING

Low Differential Capacitance.. 39 pF max.

..... UL Recognized Components

Rated for International Surge Wave  
Shapes

**SMBJ Package (Top View)**

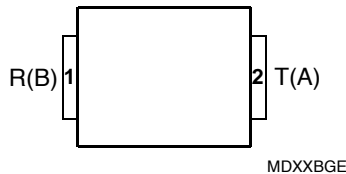

**Device Symbol**

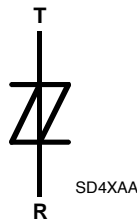

Terminals T and R correspond to the alternative line designators of A and B

**Additional Information**

Click these links for more information:



[PRODUCT SELECTOR](#) [TECHNICAL LIBRARY](#) [INVENTORY](#) [SAMPLES](#) [CONTACT](#)

**Description**

These protector pairs have been formulated to limit the peak voltages on the line terminals of the '7581/2/3 LCAS (Line Card Access Switches) type devices. An LCAS may also be referred to as a Solid State Relay, SSR, i.e. a replacement of the conventional electro-mechanical relay.

Overvoltages are normally caused by a.c. power system or lightning flash disturbances which are induced or conducted on to the telephone line. These overvoltages are initially clipped by protector breakdown clamping until the voltage rises to the breakover level, which causes the device to crowbar into a low-voltage on state. This low-voltage on state causes the current resulting from the overvoltage to be safely diverted through the device. For negative surges, the high crowbar holding current helps prevent d.c. latchup with the SLIC current, as the surge current subsides.

Each protector consists of a symmetrical voltage-triggered bidirectional thyristor. They are guaranteed to voltage limit and withstand the listed international lightning surges in both polarities.

Wave Shape	Standard	I <sub>TSP</sub> A	
		H3 Series	M3 Series
2/10 $\mu$ s	GR-1089-CORE	500	300
8/20 $\mu$ s	IEC 61000-4-5	300	220
10/160 $\mu$ s	FCC Part 68	250	120
10/700 $\mu$ s	ITU-T K.20/21/45	200	100
10/560 $\mu$ s	FCC Part 68	160	75
10/1000 $\mu$ s	GR-1089-CORE	100	50

**How to Order**

Device	Package	Carrier	Order As
TISP4125H3BJ	BJ (J-Bend DO-214AA/SMB)	Embossed Tape Reeled	TISP4125H3BJR-S
TISP4219H3BJ			TISP4219H3BJR-S
TISP4125M3BJ			TISP4125M3BJR-S
TISP4219M3BJ			TISP4219M3BJR-S



**WARNING Cancer and Reproductive Harm**  
[www.P65Warnings.ca.gov](http://www.P65Warnings.ca.gov)

JUNE 2001 – REVISED JANUARY 2007

\*RoHS Directive 2015/863, Mar 31, 2015 and Annex.  
Specifications are subject to change without notice.

Users should verify actual device performance in their specific applications.

The products described herein and this document are subject to specific legal disclaimers as set forth on the last page of this document, and at [www.bourns.com/docs/legal/disclaimer.pdf](http://www.bourns.com/docs/legal/disclaimer.pdf).

## TISP4125H3BJ & TISP4219H3BJ

### Absolute Maximum Ratings, $T_A = 25\text{ °C}$ (Unless Otherwise Noted)

Rating	Symbol	Value	Unit
Repetitive peak off-state voltage, (see Note 1)	$V_{DRM}$	$\pm 100$ $\pm 180$	V
Non-repetitive peak on-state pulse current (see Notes 2 and 3) 2/10 $\mu s$ (GR-1089-CORE, 2/10 $\mu s$ voltage wave shape) 8/20 $\mu s$ (IEC 61000-4-5, 1.2/50 $\mu s$ voltage, 8/20 current combination wave generator) 10/160 $\mu s$ (FCC Part 68, 10/160 $\mu s$ voltage wave shape) 5/200 $\mu s$ (VDE 0433, 10/700 $\mu s$ voltage wave shape) 0.2/310 $\mu s$ (I3124, 0.5/700 $\mu s$ voltage wave shape) 5/310 $\mu s$ (ITU-T K.20/21, 10/700 $\mu s$ voltage wave shape) 5/310 $\mu s$ (FTZ R12, 10/700 $\mu s$ voltage wave shape) 10/560 $\mu s$ (FCC Part 68, 10/560 $\mu s$ voltage wave shape) 10/1000 $\mu s$ (GR-1089-CORE, 10/1000 $\mu s$ voltage wave shape)	$I_{TSP}$	500 300 250 220 200 200 200 160 100	A
Non-repetitive peak on-state current (see Notes 2, 3 and 4) 20 ms (50 Hz) full sine wave 16.7 ms (60 Hz) full sine wave 1000 s 50 Hz/60 Hz a.c.	$I_{TSM}$	55 60 2.1	A
Initial rate of rise of on-state current, Exponential current ramp, Maximum ramp value < 200 A	$di_T/dt$	400	A/ $\mu s$
Junction temperature	$T_J$	-40 to +150	$^{\circ}C$
Storage temperature range	$T_{stg}$	-65 to +150	$^{\circ}C$

- NOTES: 1. See Applications Information for voltage values at lower temperatures.  
 2. Initially, the TISP4xxxH3BJ must be in thermal equilibrium with  $T_J = 25\text{ °C}$ .  
 3. The surge may be repeated after the TISP4xxxH3BJ returns to its initial conditions.  
 4. EIA/JESD51-2 environment and EIA/JESD51-3 PCB with standard footprint dimensions connected with 5 A rated printed wiring track widths. See Figure 10 for the current ratings at other durations. Derate current values at  $-0.61\%/^{\circ}C$  for ambient temperatures above  $25\text{ °C}$ .

### Recommended Operating Conditions

Component	Condition	Min	Typ	Max	Unit
$R_S$ Series current limiting resistor	GR-1089-CORE first-level surge survival	0			$\Omega$
	GR-1089-CORE first-level and second-level surge survival	0			$\Omega$
	K.20, K.21 and K.45 coordination pass with a 400 V primary protector	6			$\Omega$
$V_{RING}$ AC ringing voltage	Figure 12, $V_{BAT} = -48\text{ V} \pm 2.5\text{ V}$ , $R1 = R2 = 300\ \Omega$ , $0\text{ °C} < T_A < +85\text{ °C}$	Battery-backed		87	V rms
		Ground-backed		101	V rms

**Electrical Characteristics, TISP4xxxH3, T<sub>A</sub> = 25 °C (Unless Otherwise Noted)**

Parameter	Test Conditions	Min	Typ	Max	Unit
I <sub>DRM</sub> Repetitive peak off-state current	V <sub>D</sub> = V <sub>DRM</sub> T <sub>A</sub> = 25 °C T <sub>A</sub> = 85 °C			±5 ±10	μA
V <sub>(BO)</sub> Breakover voltage	dv/dt = ±250 V/ms, R <sub>SOURCE</sub> = 300 Ω	'4125 '4219		±125 ±219	V
V <sub>(BO)</sub> Impulse breakover voltage	dv/dt ≤ ±1000 V/μs, Linear voltage ramp, Maximum ramp value = ±500 V di/dt = ±20 A/μs, Linear current ramp, Maximum ramp value = ±10 A	'4125 '4219		±134 ±229	V
I <sub>(BO)</sub> Breakover current	dv/dt = ±250 V/ms, R <sub>SOURCE</sub> = 300 Ω	±0.15		±0.6	A
V <sub>T</sub> On-state voltage	I <sub>T</sub> = ±5 A, t <sub>W</sub> = 100 μs			±3	V
I <sub>H</sub> Holding current	I <sub>T</sub> = ±5A, di/dt = +/-30 mA/ms	±0.15		± 0.6	A
dv/dt Critical rate of rise of off-state voltage	Linear voltage ramp, Maximum ramp value < 0.85V <sub>DRM</sub>	±5			kV/μs
I <sub>D</sub> Off-state current	V <sub>D</sub> = ± 50 V T <sub>A</sub> = 85 °C			±10	μA
C <sub>off</sub> Off-state capacitance	f = 1 MHz, V <sub>d</sub> = 1 V rms, V <sub>D</sub> = 0, f = 1 MHz, V <sub>d</sub> = 1 V rms, V <sub>D</sub> = -1 V f = 1 MHz, V <sub>d</sub> = 1 V rms, V <sub>D</sub> = -2 V f = 1 MHz, V <sub>d</sub> = 1 V rms, V <sub>D</sub> = -50 V f = 1 MHz, V <sub>d</sub> = 1 V rms, V <sub>D</sub> = -100 V (see Note 5)		80 71 65 30 23	90 79 74 35 28	pF

NOTE 5: To avoid possible voltage clipping, the '4125 is tested with V<sub>D</sub> = -98 V.

**Thermal Characteristics**

Parameter	Test Conditions	Min	Typ	Max	Unit
R <sub>θJA</sub> Junction to free air thermal resistance	EIA/JESD51-3 PCB, I <sub>T</sub> = I <sub>TSM(1000)</sub> , T <sub>A</sub> = 25 °C, (see Note 6)			113	°C/W
	265 mm x 210 mm populated line card, 4-layer PCB, I <sub>T</sub> = I <sub>TSM(1000)</sub> , T <sub>A</sub> = 25 °C		50		

NOTE 6: EIA/JESD51-2 environment and the PCB has standard foot print dimensions connected with 5 A rated printed wiring track widths.

## TISP4125M3BJ & TISP4219M3BJ

### Absolute Maximum Ratings, $T_A = 25\text{ °C}$ (Unless Otherwise Noted)

Rating	Symbol	Value	Unit
Repetitive peak off-state voltage, (see Note 7)	$V_{DRM}$	±100	V
		±180	
Non-repetitive peak on-state pulse current (see Notes 8 and 9)	$I_{TSP}$	300	A
2/10 $\mu\text{s}$ (GR-1089-CORE, 2/10 $\mu\text{s}$ voltage wave shape)		220	
8/20 $\mu\text{s}$ (IEC 61000-4-5, 1.2/50 $\mu\text{s}$ voltage, 8/20 current combination wave generator)		120	
10/160 $\mu\text{s}$ (FCC Part 68, 10/160 $\mu\text{s}$ voltage wave shape)		110	
5/200 $\mu\text{s}$ (VDE 0433, 10/700 $\mu\text{s}$ voltage wave shape)		100	
0.2/310 $\mu\text{s}$ (I3124, 0.5/700 $\mu\text{s}$ voltage wave shape)		100	
5/310 $\mu\text{s}$ (ITU-T K.20/21, 10/700 $\mu\text{s}$ voltage wave shape)		100	
5/310 $\mu\text{s}$ (FTZ R12, 10/700 $\mu\text{s}$ voltage wave shape)		75	
10/560 $\mu\text{s}$ (FCC Part 68, 10/560 $\mu\text{s}$ voltage wave shape)		50	
10/1000 $\mu\text{s}$ (GR-1089-CORE, 10/1000 $\mu\text{s}$ voltage wave shape)			
Non-repetitive peak on-state current (see Notes 8, 9 and 10)	$I_{TSM}$	30	A
20 ms (50 Hz) full sine wave		32	
16.7 ms (60 Hz) full sine wave		2.1	
1000 s 50 Hz/60 Hz a.c.			
Initial rate of rise of on-state current, Exponential current ramp, Maximum ramp value < 200 A	$di_T/dt$	300	A/ $\mu\text{s}$
Junction temperature	$T_J$	-40 to +150	°C
Storage temperature range	$T_{stg}$	-65 to +150	°C

- NOTES: 7. See Applications Information for voltage values at lower temperatures.  
 8. Initially, the TISP4xxxM3BJ must be in thermal equilibrium with  $T_J = 25\text{ °C}$ .  
 9. The surge may be repeated after the TISP4xxxM3BJ returns to its initial conditions.  
 10. EIA/JESD51-2 environment and EIA/JESD51-3 PCB with standard footprint dimensions connected with 5 A rated printed wiring track widths. See Figure 11 for the current ratings at other durations. Derate current values at  $-0.61\text{ %/°C}$  for ambient temperatures above  $25\text{ °C}$ .

### Recommended Operating Conditions

Component	Condition	Min	Typ	Max	Unit
$R_S$ Series current limiting resistor	GR-1089-CORE first-level surge survival	10			$\Omega$
	GR-1089-CORE first-level and second-level surge survival	12			$\Omega$
	K.20, K.21 and K.45 coordination pass with a 400 V primary protector	6			$\Omega$
$V_{RING}$ AC ringing voltage	Figure 12, $V_{BAT} = -48\text{ V} \pm 2.5\text{ V}$ , $R1 = R2 = 300\ \Omega$ , $0\text{ °C} < T_A < +85\text{ °C}$	Battery-backed		87	V rms
		Ground-backed		101	V rms

## Electrical Characteristics, TISP4xxxM3, T<sub>A</sub> = 25 °C (Unless Otherwise Noted)

Parameter	Test Conditions	Min	Typ	Max	Unit
I <sub>DRM</sub> Repetitive peak off-state current	V <sub>D</sub> = V <sub>DRM</sub> T <sub>A</sub> = 25 °C T <sub>A</sub> = 85 °C			±5 ±10	μA
V <sub>(BO)</sub> Breakover voltage	dv/dt = ±250 V/ms, R <sub>SOURCE</sub> = 300 Ω	'4125 '4219		±125 ±219	V
V <sub>(BO)</sub> Impulse breakover voltage	dv/dt ≤ ±1000 V/s, Linear voltage ramp, Maximum ramp value = ±500 V di/dt = ±20 A/μs, Linear current ramp, Maximum ramp value = ±10 A	'4125 '4219		±132 ±226	V
I <sub>(BO)</sub> Breakover current	dv/dt = ±250 V/ms, R <sub>SOURCE</sub> = 300 Ω	±0.15		±0.6	A
V <sub>T</sub> On-state voltage	I <sub>T</sub> = ±5 A, t <sub>W</sub> = 100 μs			±3	V
I <sub>H</sub> Holding current	I <sub>T</sub> = ±5A, di/dt = +/-30 mA/ms	±0.15		±0.6	A
dv/dt Critical rate of rise of off-state voltage	Linear voltage ramp, Maximum ramp value < 0.85V <sub>DRM</sub>	±5			kV/μs
I <sub>D</sub> Off-state current	V <sub>D</sub> = ±50 V T <sub>A</sub> = 85 °C			±10	μA
C <sub>off</sub> Off-state capacitance	f = 1 MHz, V <sub>d</sub> = 1 V rms V <sub>D</sub> = 0, f = 1 MHz, V <sub>d</sub> = 1 V rms V <sub>D</sub> = -1 V f = 1 MHz, V <sub>d</sub> = 1 V rms V <sub>D</sub> = -2 V f = 1 MHz, V <sub>d</sub> = 1 V rms V <sub>D</sub> = -50 V f = 1 MHz, V <sub>d</sub> = 1 V rms V <sub>D</sub> = -100 V (see Note 11)		62 56 52 26 21	74 67 62 31 25	pF

NOTE 11: To avoid possible voltage clipping, the '4125 is tested with V<sub>D</sub> = -98 V.

## Thermal Characteristics

Parameter	Test Conditions	Min	Typ	Max	Unit
R <sub>θJA</sub> Junction to free air thermal resistance	EIA/JESD51-3 PCB, I <sub>T</sub> = I <sub>TSM(1000)</sub> , T <sub>A</sub> = 25 °C, (see Note 12)			115	°C/W
	265 mm x 210 mm populated line card, 4-layer PCB, I <sub>T</sub> = I <sub>TSM(1000)</sub> , T <sub>A</sub> = 25 °C		52		

NOTE 12: EIA/JESD51-2 environment and the PCB has standard footprint dimensions connected with 5 A rated printed wiring track widths.

Parameter Measurement Information

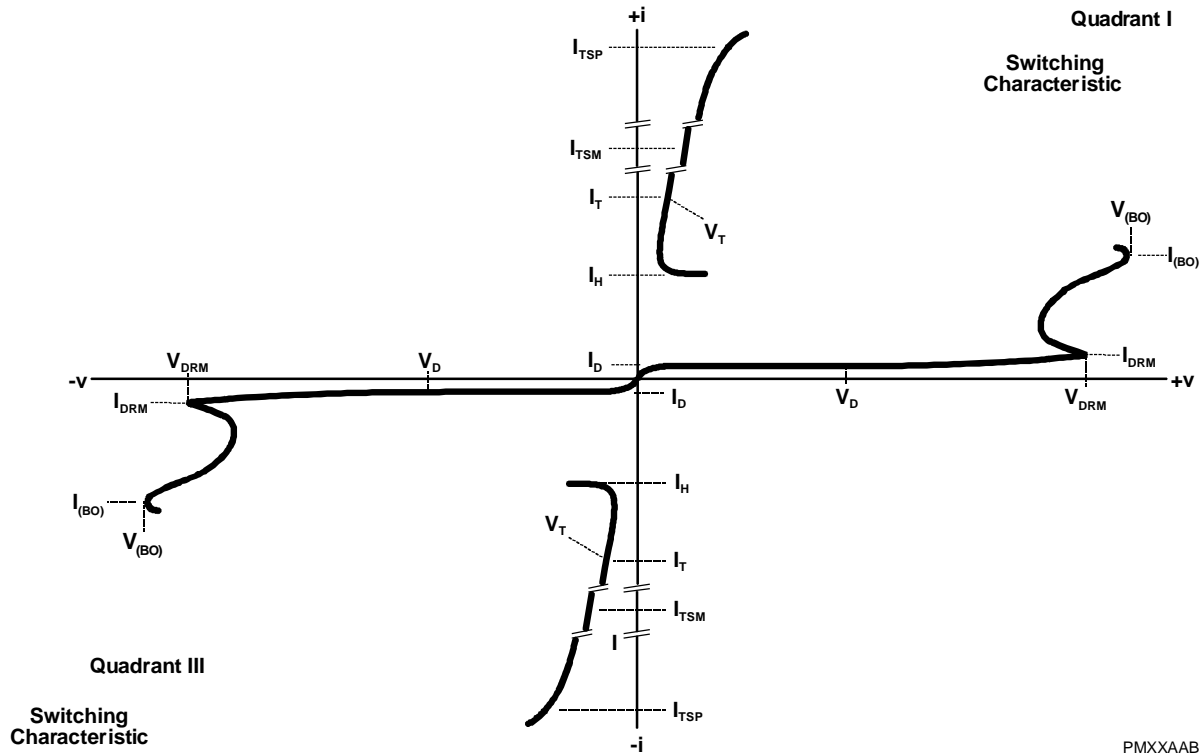

Figure 1. Voltage-Current Characteristic for T and R Terminals  
All Measurements are Referenced to the R Terminal

TISP4xxxH3BJ Typical Characteristics

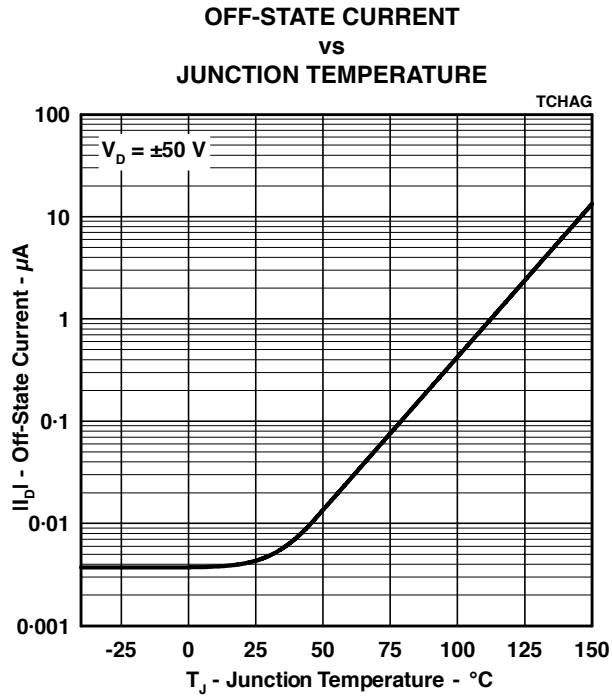

Figure 2.

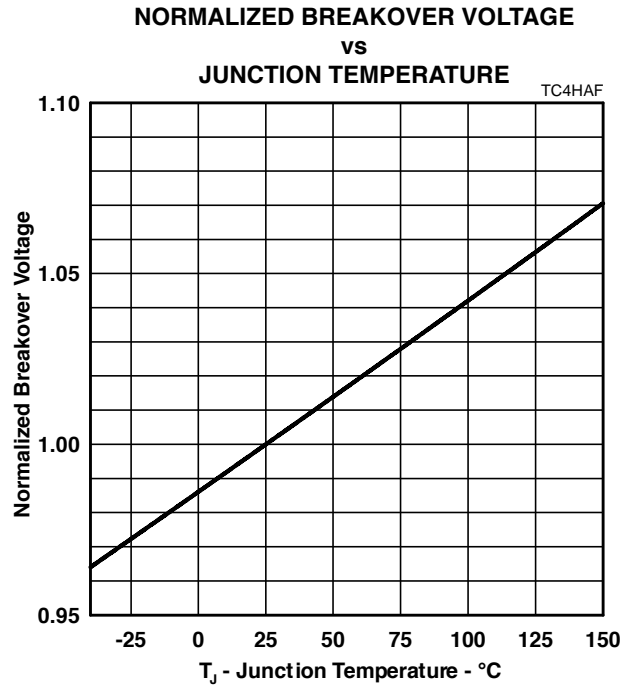

Figure 3.

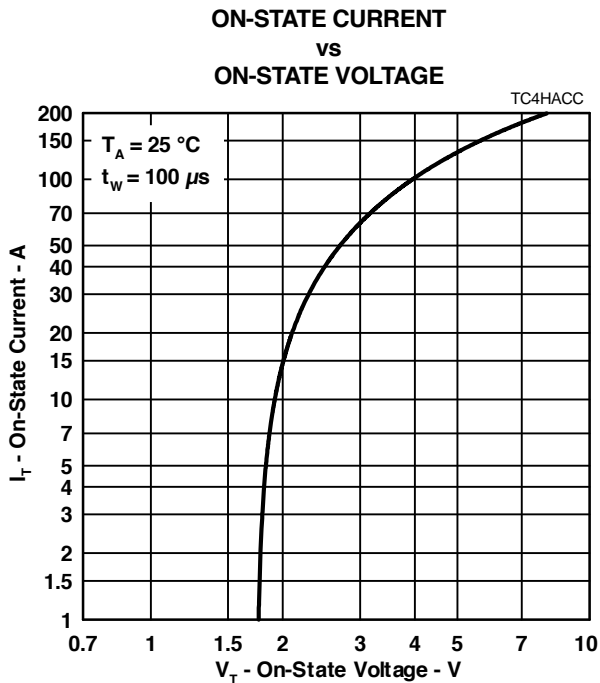

Figure 4.

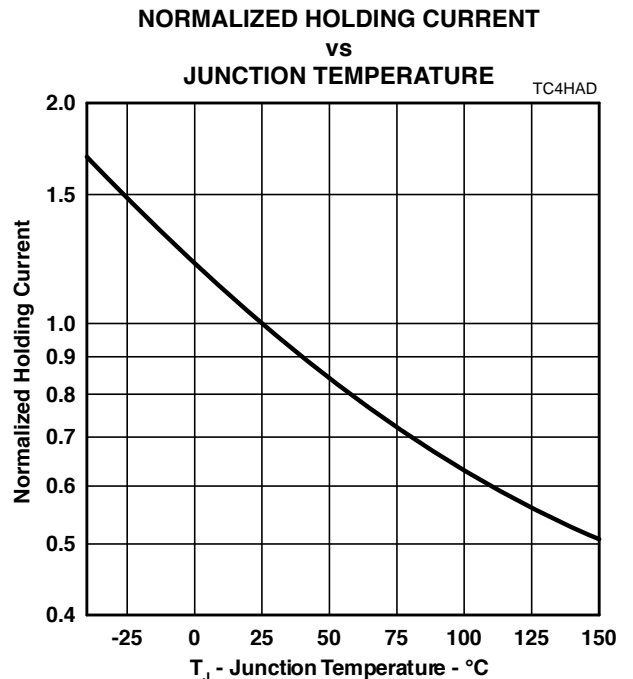

Figure 5.

JUNE 2001 – REVISED JANUARY 2007

Specifications are subject to change without notice.

Users should verify actual device performance in their specific applications.

The products described herein and this document are subject to specific legal disclaimers as set forth on the last page of this document, and at [www.bourns.com/docs/legal/disclaimer.pdf](http://www.bourns.com/docs/legal/disclaimer.pdf).

TISP4xxxM3BJ Typical Characteristics

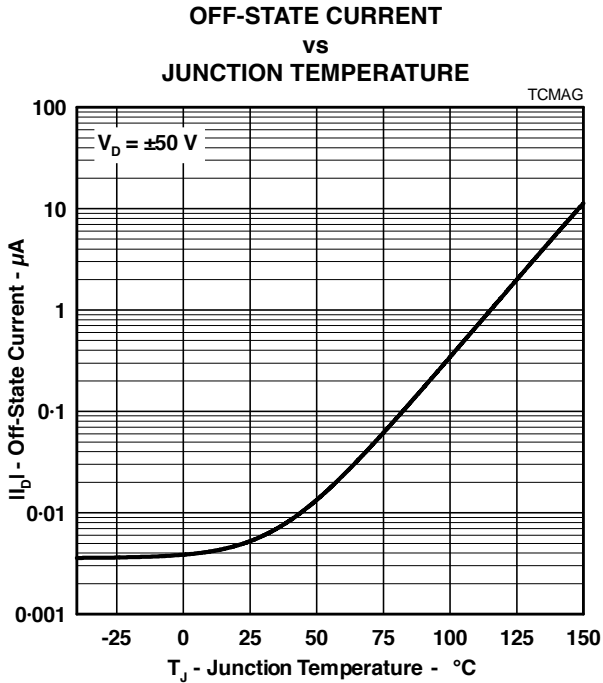

Figure 6.

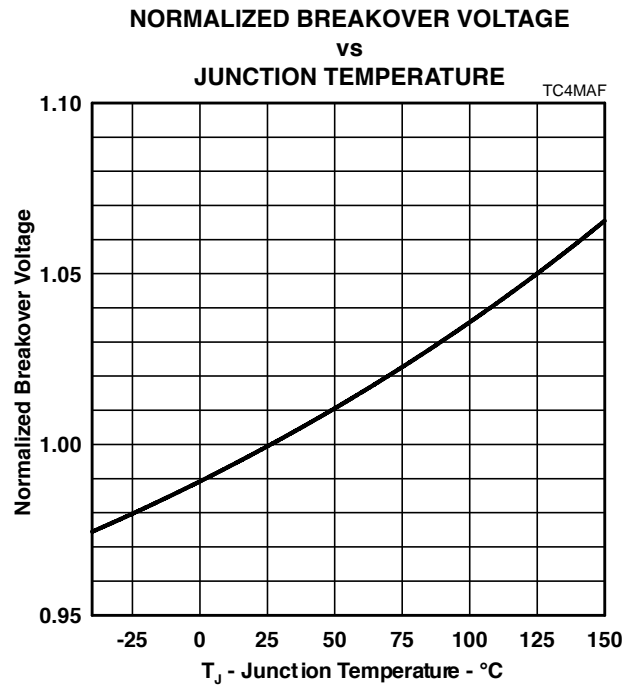

Figure 7.

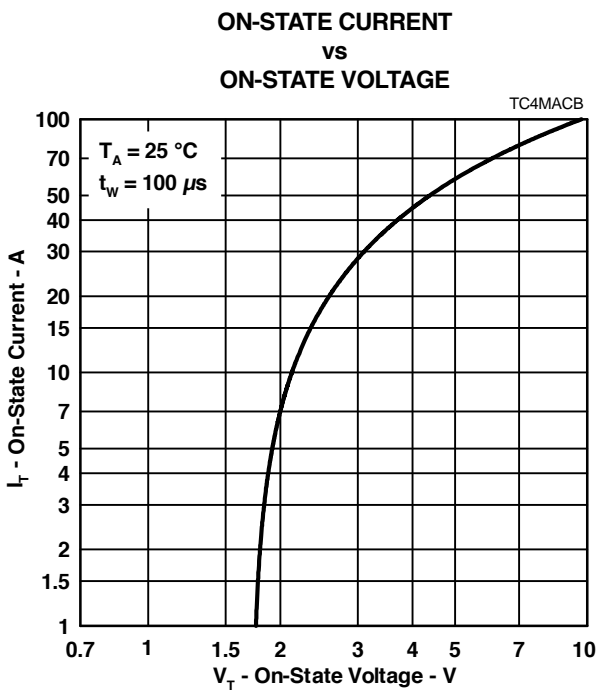

Figure 8.

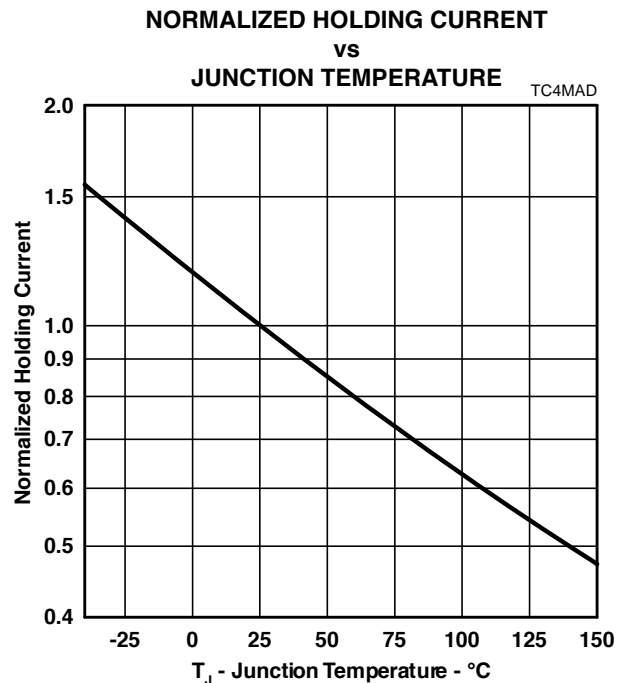

Figure 9.

JUNE 2001 – REVISED JANUARY 2007

Specifications are subject to change without notice.

Users should verify actual device performance in their specific applications.

The products described herein and this document are subject to specific legal disclaimers as set forth on the last page of this document, and at [www.bourns.com/docs/legal/disclaimer.pdf](http://www.bourns.com/docs/legal/disclaimer.pdf).



Rating Information

TISP4xxxH3BJ

NON-REPETITIVE PEAK ON-STATE CURRENT  
VS  
CURRENT DURATION

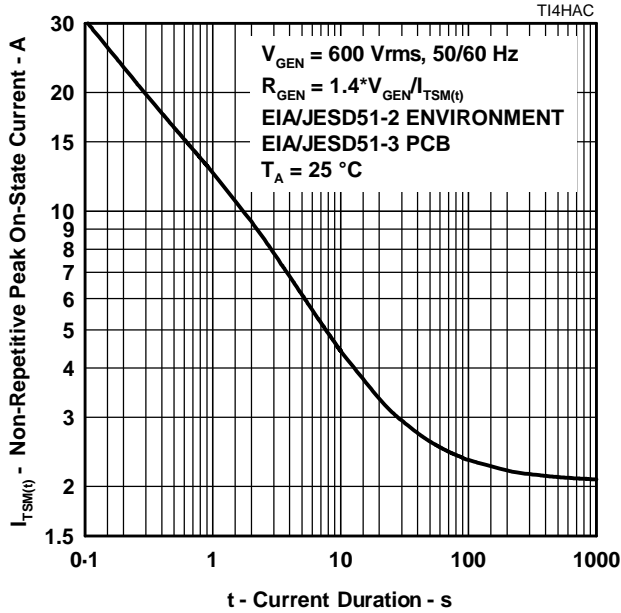

Figure 10.

TISP4xxxM3BJ

NON-REPETITIVE PEAK ON-STATE CURRENT  
VS  
CURRENT DURATION

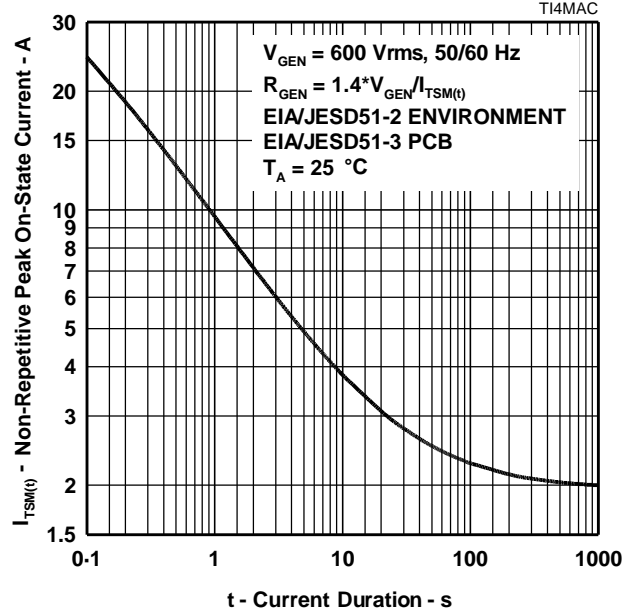

Figure 11.

APPLICATIONS INFORMATION

Introduction

These protector pairs have been designed to limit the peak voltages on the line terminals of '7581/7582/7583 LCAS (Line Card Access Switch) parts. An LCAS may also be referred to as a Solid-State Relay, SSR, i.e. a replacement of the conventional electro-mechanical relay.

The '7581 LCAS has two solid-state switches which connect the telephone line to the line card SLIC (Subscriber Line Interface Circuit), Figure 12, SW1 and SW2. A further two solid-state switches connect the telephone ringing generator to the line, Figure 12, SW3 and SW4. Applied 5-volt logic signals control the condition of the switches to perform the functions of line disconnect, connection to the SLIC and application of ringing. If excessive long-term overdissipation occurs, a thermal sensor activates thermal shutdown and opens the switches. The SLIC side of switches SW1 and SW2 is limited in voltage by internal protectors Th3 and Th4. The line-side of the LCAS is voltage limited by the two TISP® parts.

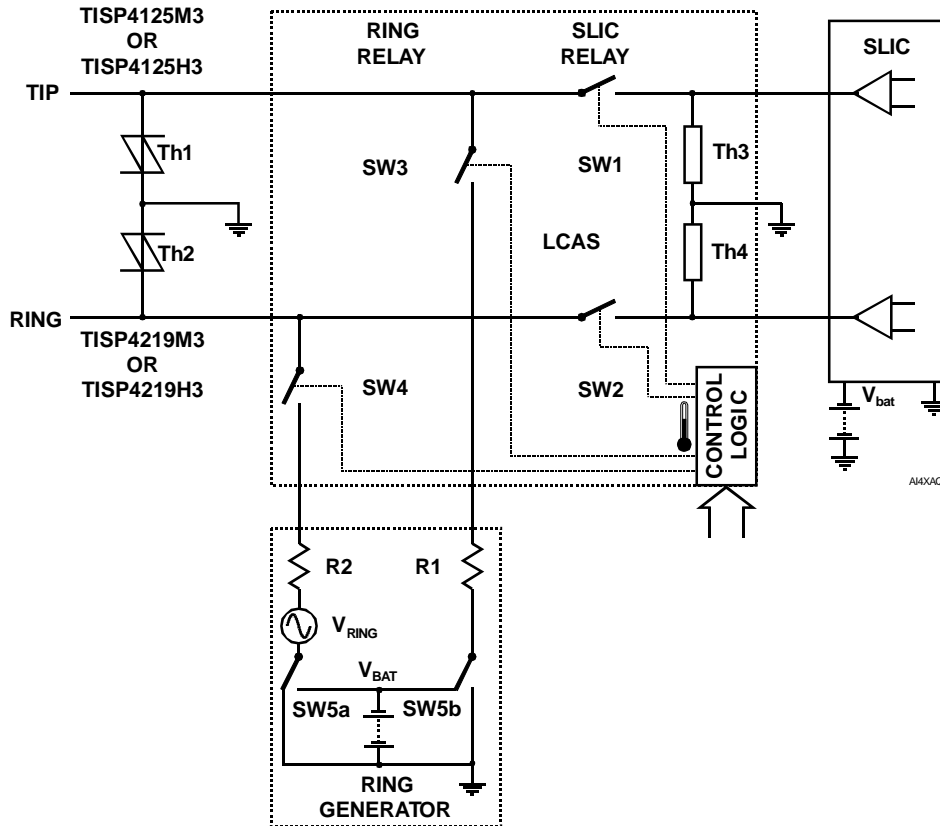

Figure 12. Basic LCAS Arrangement

Additional functions are provided by the '7582 (line test access) and the '7583 (test-in and test-out access). Up to three conventional electro-mechanical relays may be replaced by the LCAS. The resulting size reduction can double the line density of a line card.

This document covers the types of overvoltage protection required by the '7581 LCAS and how the TISP® part voltages are selected to provide these requirements. The LCAS '7582 and '7583 are also covered as the additional switches used in these parts are similar to the '7581.

## LCAS Switch Ratings

When a switch is in the off state, the maximum withstand voltage may be set by the switch itself or by the control line to the switch. At 25 °C, the switch terminal to ground voltage rating for all the switches is  $\pm 320$  V. Switches SW1 to SW3 are bidirectional MOS types and can withstand  $\pm 320$  V between terminals. Switch SW4 is a bidirectional thyristor which is rated at  $\pm 465$  V between terminals.

Overcurrents as well as overvoltages occur on telephone lines. In the on state, the thyristor switch, SW4, is capable of withstanding high levels of current overload. For currents above about 200 mA, the MOS switches, SW1 to SW3, will go into a current limited condition. This will cause the voltage to rise across the switch and large amounts of power to be developed. In the longer term, this power loss increases the overall chip temperature. When the temperature exceeds about 125 °C, thermal shutdown occurs and the switches are set to the off state. Without power loss, the LCAS will cool. Eventually, the thermal trip will reset, setting the switches back in the high power loss condition again. The cycle of temperature increase, thermal shutdown, temperature decrease and switch re-activation will continue until the overcurrent ceases.

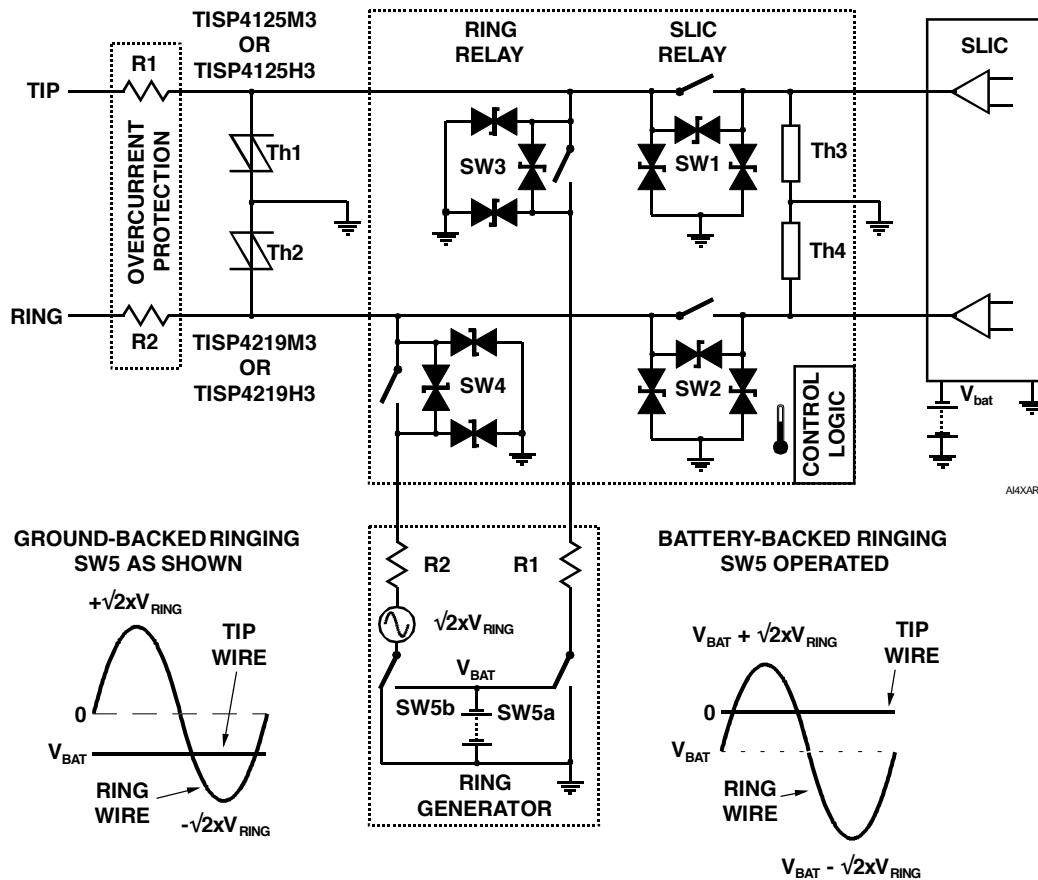

Figure 13. LCAS Shown with Switch Breakdown Limits

## Equivalent Circuit

Figure 13 shows the LCAS switch voltage ratings as breakdown diodes, which must not be allowed to conduct. Each switch has three diodes; one between poles and the other two from each pole to ground. At 25 °C, switches SW1 through to SW3 have breakdown diode voltages of  $\pm 320$  V. Switch SW4 has breakdown diode voltage values of  $\pm 465$  V for the one between poles and  $\pm 320$  V for the two diodes connected to ground. Note that only protection to ground is required, as in the limit, the inter-switch voltage limitation of  $\pm 640$  V is the same as the switch to ground limitation of +320 V and -320 V in both polarities.

JUNE 2001 – REVISED JANUARY 2007

Specifications are subject to change without notice.

Users should verify actual device performance in their specific applications.

The products described herein and this document are subject to specific legal disclaimers as set forth on the last page of this document, and at [www.bourns.com/docs/legal/disclaimer.pdf](http://www.bourns.com/docs/legal/disclaimer.pdf).

## Protector Voltages

Protector working and protection voltage design calculations for the LCAS are described in the IEEE Std. C62.37.1-2000, **IEEE Guide for the Application of Thyristor Surge Protection Devices**, pp 40-43. These calculations comprehend:

- the temperature variation of LCAS voltage ratings,
- increase in protection voltage with ambient temperature rise, long term a.c. heating and under impulse conditions,
- decrease in working voltage with ambient temperature fall,
- ground-backed and battery-backed ringing configurations (see Figure 13).

These calculation techniques were used to set the TISP® part voltages. Using these TISP® parts allows normal system voltage levels of  $\pm 100$  V on TIP and  $\pm 180$  V on RING without clipping at 25 °C. At 0 °C ambient, these voltage levels become  $\pm 97$  V on TIP and  $\pm 174$  V on RING. Under open circuit line conditions, this means that the peak ringing voltage cannot exceed  $\pm 174$  V for equipment operation down to 0 °C ambient.

Assuming a battery voltage of 48 V  $\pm 2.5$  V and battery-backed ringing, the maximum peak a.c. ring voltage is  $174 \text{ V} - 50.5 \text{ V} = 123.5 \text{ V}$  or 87 V rms. The working voltage of  $\pm 97$  V on TIP is more than half the  $\pm 174$  V working voltage on RING. As a result, the TIP working voltage does not represent a limitation for systems where the TIP return resistance is equal or less than the RING source resistance.

For balanced impedance ground-backed ringing, the maximum peak a.c. ring voltage under short line conditions (short between TIP and RING) is limited by the TIP working voltage of  $\pm 97$  V. In the negative ring polarity, the limit of the voltage is made up from half the battery voltage plus half of the peak a.c. ring voltage. The maximum peak a.c. ring voltage is  $2 \times (97 - 50.5/2) = 143.5 \text{ V}$  or 101 V rms.

Line test voltage levels must be considered, whether they be applied by using LCAS switches or separate electro-mechanical relays. For these TISP® parts, the applied test voltage should not exceed the lowest working voltage, which is  $\pm 97$  V.

## MECHANICAL DATA

### Recommended Printed Wiring Footprint

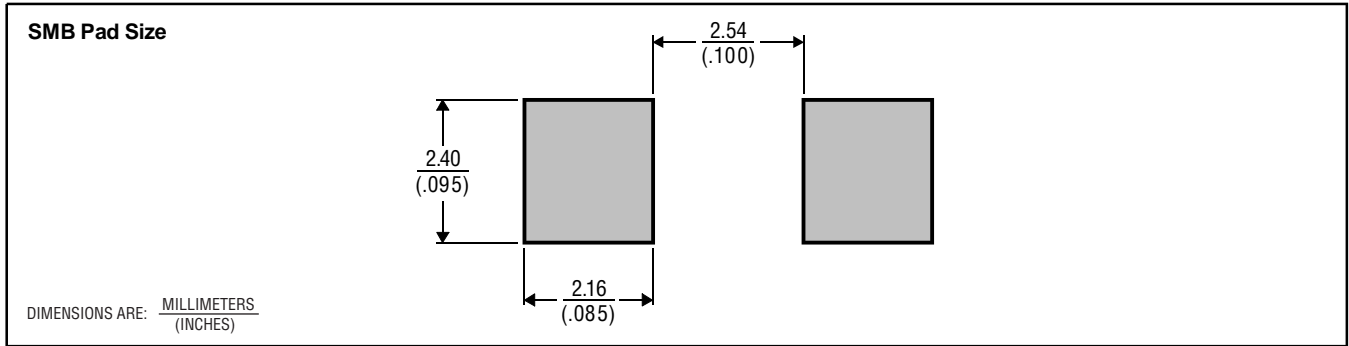

MDXXBIA

### Device Symbolization Code

Devices will be coded as below. As the device parameters are symmetrical, terminal 1 is not identified.

Device	Symbolization Code
TISP4125H3BJ	4125H3
TISP4219H3BJ	4219H3
TISP4125M3BJ	4125M3
TISP4219M3BJ	4219M3

**Asia-Pacific:** Tel: +886-2 2562-4117 • Email: asiacus@bourns.com

**EMEA:** Tel: +36 88 885 877 • Email: eurocus@bourns.com

**The Americas:** Tel: +1-951 781-5500 • Email: americus@bourns.com

**www.bourns.com**

"TISP" is a trademark of Bourns, Ltd., a Bourns Company, and is Registered in the U.S. Patent and Trademark Office.  
 "Bourns" is a registered trademark of Bourns, Inc. in the U.S. and other countries.

JUNE 2001 – REVISED JANUARY 2007

Specifications are subject to change without notice.

Users should verify actual device performance in their specific applications.

The products described herein and this document are subject to specific legal disclaimers as set forth on the last page of this document, and at [www.bourns.com/docs/legal/disclaimer.pdf](http://www.bourns.com/docs/legal/disclaimer.pdf).

This legal disclaimer applies to purchasers and users of Bourns® products manufactured by or on behalf of Bourns, Inc. and its affiliates (collectively, “Bourns”).

Unless otherwise expressly indicated in writing, Bourns® products and data sheets relating thereto are subject to change without notice. Users should check for and obtain the latest relevant information and verify that such information is current and complete before placing orders for Bourns® products.

The characteristics and parameters of a Bourns® product set forth in its data sheet are based on laboratory conditions, and statements regarding the suitability of products for certain types of applications are based on Bourns’ knowledge of typical requirements in generic applications. The characteristics and parameters of a Bourns® product in a user application may vary from the data sheet characteristics and parameters due to (i) the combination of the Bourns® product with other components in the user’s application, or (ii) the environment of the user application itself. The characteristics and parameters of a Bourns® product also can and do vary in different applications and actual performance may vary over time. Users should always verify the actual performance of the Bourns® product in their specific devices and applications, and make their own independent judgments regarding the amount of additional test margin to design into their device or application to compensate for differences between laboratory and real world conditions.

Unless Bourns has explicitly designated an individual Bourns® product as meeting the requirements of a particular industry standard (e.g., ISO/TS 16949) or a particular qualification (e.g., UL listed or recognized), Bourns is not responsible for any failure of an individual Bourns® product to meet the requirements of such industry standard or particular qualification. Users of Bourns® products are responsible for ensuring compliance with safety-related requirements and standards applicable to their devices or applications.

Bourns® products are not recommended, authorized or intended for use in nuclear, lifesaving, life-critical or life-sustaining applications, nor in any other applications where failure or malfunction may result in personal injury, death, or severe property or environmental damage. Unless expressly and specifically approved in writing by two authorized Bourns representatives on a case-by-case basis, use of any Bourns® products in such unauthorized applications might not be safe and thus is at the user’s sole risk. Life-critical applications include devices identified by the U.S. Food and Drug Administration as Class III devices and generally equivalent classifications outside of the United States.

Bourns expressly identifies those Bourns® standard products that are suitable for use in automotive applications on such products’ data sheets in the section entitled “Applications.” Unless expressly and specifically approved in writing by two authorized Bourns representatives on a case-by-case basis, use of any other Bourns® standard products in an automotive application might not be safe and thus is not recommended, authorized or intended and is at the user’s sole risk. If Bourns expressly identifies a sub-category of automotive application in the data sheet for its standard products (such as infotainment or lighting), such identification means that Bourns has reviewed its standard product and has determined that if such Bourns® standard product is considered for potential use in automotive applications, it should only be used in such sub-category of automotive applications. Any reference to Bourns® standard product in the data sheet as compliant with the AEC-Q standard or “automotive grade” does not by itself mean that Bourns has approved such product for use in an automotive application.

Bourns® standard products are not tested to comply with United States Federal Aviation Administration standards generally or any other generally equivalent governmental organization standard applicable to products designed or manufactured for use in aircraft or space applications. Bourns expressly identifies Bourns® standard products that are suitable for use in aircraft or space applications on such products’ data sheets in the section entitled “Applications.” Unless expressly and specifically approved in writing by two authorized Bourns representatives on a case-by-case basis, use of any other Bourns® standard product in an aircraft or space application might not be safe and thus is not recommended, authorized or intended and is at the user’s sole risk.

The use and level of testing applicable to Bourns® custom products shall be negotiated on a case-by-case basis by Bourns and the user for which such Bourns® custom products are specially designed. Absent a written agreement between Bourns and the user regarding the use and level of such testing, the above provisions applicable to Bourns® standard products shall also apply to such Bourns® custom products.

Users shall not sell, transfer, export or re-export any Bourns® products or technology for use in activities which involve the design, development, production, use or stockpiling of nuclear, chemical or biological weapons or missiles, nor shall they use Bourns® products or technology in any facility which engages in activities relating to such devices. The foregoing restrictions apply to all uses and applications that violate national or international prohibitions, including embargos or international regulations. Further, Bourns® products and Bourns technology and technical data may not under any circumstance be exported or re-exported to countries subject to international sanctions or embargoes. Bourns® products may not, without prior authorization from Bourns and/or the U.S. Government, be resold, transferred, or re-exported to any party not eligible to receive U.S. commodities, software, and technical data.

To the maximum extent permitted by applicable law, Bourns disclaims (i) any and all liability for special, punitive, consequential, incidental or indirect damages or lost revenues or lost profits, and (ii) any and all implied warranties, including implied warranties of fitness for particular purpose, non-infringement and merchantability.

*For your convenience, copies of this Legal Disclaimer Notice with German, Spanish, Japanese, Traditional Chinese and Simplified Chinese bilingual versions are available at:*

*Web Page:* <http://www.bourns.com/legal/disclaimers-terms-and-policies>

*PDF:* <http://www.bourns.com/docs/Legal/disclaimer.pdf>