



Features

- Thick film technology
- Power rating up to 1.5 watts @ 70 °C
- High power surge withstanding
- RoHS compliant*
- Halogen free**
- AEC-Q200 compliant

Applications

- Power supplies
- Digital meters
- Consumer electronics
- LED lighting
- Industry control boards

CMP-Q Series High Power Anti-Surge Chip Resistor

Electrical Characteristics

Characteristic	Model				
	CMP0603Q	CMP0805Q	CMP1206Q	CMP2010Q	CMP2512Q
Power Rating @ 70 °C	0.25 W	0.5 W	0.75 W	1 W	1.5 W
Operating Temperature Range	-55 °C to +155 °C				
Derated to Zero Load at	+155 °C				
Maximum Working Voltage	75 V	200 V	250 V	200 V	300 V
Maximum Overload Voltage	125 V	300 V	500 V	400 V	600 V
Resistance Tolerance	±1 %, ±5 %				
Temperature Coefficient 10 Ω to 1 MΩ (±1 %, E24 & E96 Series)	±100 ppm/°C	±100 ppm/°C	±100 ppm/°C	±100 ppm/°C	±100 ppm/°C
10 Ω to 1 MΩ (±5 %, E24 Series)	±200 ppm/°C	±200 ppm/°C	±200 ppm/°C	±200 ppm/°C	±200 ppm/°C

Note: Solder pad and trace size should be evaluated and board surface temperature should not exceed +105 °C when applying full rated power.

Additional Information

Click these links for more information:



[PRODUCT SELECTOR](#) [TECHNICAL LIBRARY](#) [INVENTORY](#) [SAMPLES](#) [CONTACT](#)

BOURNS®

Asia-Pacific: Tel: +886-2 2562-4117 • Email: asiacus@bourns.com

EMEA: Tel: +36 88 885 877 • Email: eurocus@bourns.com

The Americas: Tel: +1-951 781-5500 • Email: americus@bourns.com

www.bourns.com



WARNING Cancer and Reproductive Harm - www.P65Warnings.ca.gov

* RoHS Directive 2015/863, Mar 31, 2015 and Annex.

** Bourns considers a product to be "halogen free" if (a) the Bromine (Br) content is 900 ppm or less; (b) the Chlorine (Cl) content is 900 ppm or less; and (c) the total Bromine (Br) and Chlorine (Cl) content is 1500 ppm or less.

Specifications are subject to change without notice.

Users should verify actual device performance in their specific applications.

The products described herein and this document are subject to specific legal disclaimers as set forth on the last page of this document, and at www.bourns.com/docs/legal/disclaimer.pdf.

CMP-Q Series High Power Anti-Surge Chip Resistors

BOURNS®

Product Dimensions

Model	L	W	C	D	T
CMP0603Q	$\frac{1.60 \pm 0.10}{(.063 \pm .004)}$	$\frac{0.80 \pm 0.10}{(.031 \pm .004)}$	$\frac{0.30 \pm 0.20}{(.012 \pm .008)}$	$\frac{0.30 \pm 0.20}{(.012 \pm .008)}$	$\frac{0.45 \pm 0.10}{(.018 \pm .004)}$
CMP0805Q	$\frac{2.00 \pm 0.10}{(.079 \pm .004)}$	$\frac{1.25 \pm 0.10}{(.049 \pm .004)}$	$\frac{0.40 \pm 0.20}{(.016 \pm .008)}$	$\frac{0.40 \pm 0.20}{(.016 \pm .008)}$	$\frac{0.50 \pm 0.10}{(.020 \pm .004)}$
CMP1206Q	$\frac{3.10 \pm 0.10}{(.122 \pm .004)}$	$\frac{1.60 \pm 0.10}{(.063 \pm .004)}$	$\frac{0.50 \pm 0.25}{(.020 \pm .010)}$	$\frac{0.50 \pm 0.25}{(.020 \pm .010)}$	$\frac{0.55 \pm 0.10}{(.022 \pm .004)}$
CMP2010Q	$\frac{5.00 \pm 0.20}{(.197 \pm .008)}$	$\frac{2.50 \pm 0.20}{(.098 \pm .008)}$	$\frac{0.65 \pm 0.25}{(.026 \pm .010)}$	$\frac{0.60 \pm 0.25}{(.023 \pm .010)}$	$\frac{0.60 \pm 0.10}{(.024 \pm .004)}$
CMP2512Q	$\frac{6.40 \pm 0.20}{(.252 \pm .008)}$	$\frac{3.10 \pm 0.20}{(.122 \pm .008)}$	$\frac{0.60 \pm 0.25}{(.024 \pm .010)}$	$\frac{1.80 \pm 0.25}{(.071 \pm .010)}$	$\frac{0.60 \pm 0.15}{(.024 \pm .006)}$

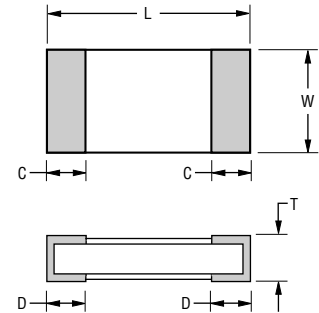

DIMENSIONS: $\frac{\text{MM}}{(\text{INCHES})}$

Recommended Solder Pad Layout

Model	A	B	L
CMP0603Q	$\frac{0.90}{(.035)}$	$\frac{1.00}{(.039)}$	$\frac{3.00}{(.118)}$
CMP0805Q	$\frac{1.30}{(.051)}$	$\frac{1.15}{(.045)}$	$\frac{3.50}{(.138)}$
CMP1206Q	$\frac{1.80}{(.071)}$	$\frac{1.30}{(.051)}$	$\frac{4.70}{(.185)}$
CMP2010Q	$\frac{3.00}{(.118)}$	$\frac{1.50}{(.059)}$	$\frac{6.80}{(.268)}$
CMP2512Q	$\frac{3.70}{(.146)}$	$\frac{2.45}{(.096)}$	$\frac{7.60}{(.299)}$

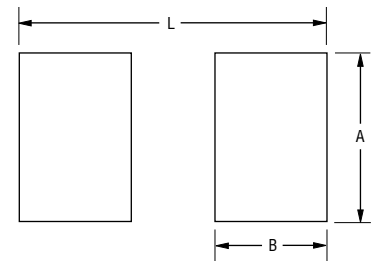

DIMENSIONS: $\frac{\text{MM}}{(\text{INCHES})}$

Surge Performance

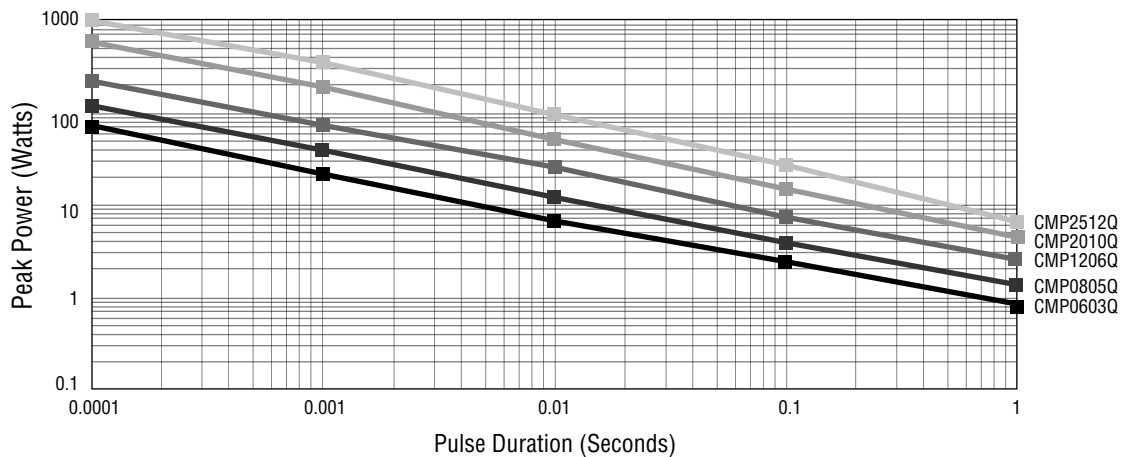

Specifications are subject to change without notice.

Users should verify actual device performance in their specific applications.

The products described herein and this document are subject to specific legal disclaimers as set forth on the last page of this document, and at www.bourns.com/docs/legal/disclaimer.pdf.

CMP-Q Series High Power Anti-Surge Chip Resistors



Construction

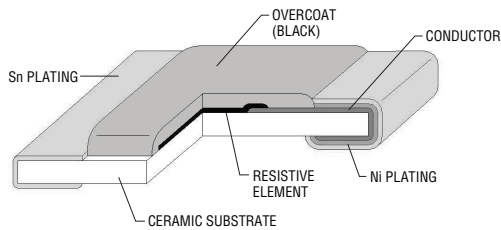

Rated Voltage

The rated voltage is calculated by the following formula:

$$V = \sqrt{P \times R}$$

V: Rated Voltage (V)
P: Rated Power (W)
R: Resistance Value (Ω)

Environmental Characteristics

Moisture Sensitivity Level..... 1

Derating Curve

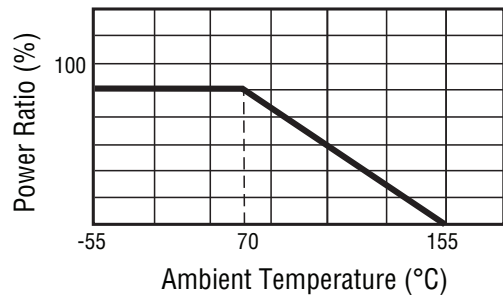

Soldering Profile

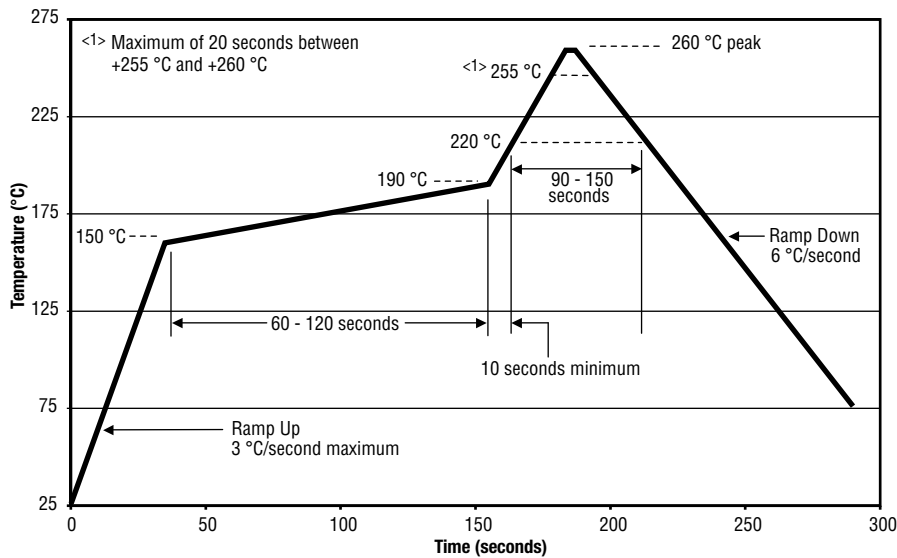

CMP-Q Series High Power Anti-Surge Chip Resistors



How to Order

CMP 0603 Q F X - 1002 E LF

<p>Model _____ CMP = High Power Anti-Surge Resistor</p> <p>Size _____ 0603 = 0603 Size 0805 = 0805 Size 1206 = 1206 Size 2010 = 2010 Size 2512 = 2512 Size</p> <p>Feature _____ Q = AEC-Q200 Compliant</p> <p>Resistance Tolerance _____ F = $\pm 1\%$ J = $\pm 5\%$</p> <p>TCR (See Electrical Characteristics chart) _____ W = ± 200 PPM/$^{\circ}$C X = ± 100 PPM/$^{\circ}$C</p> <p>Resistance Value _____ <u>1 % Tolerance:</u> $< 100 \Omega$....."R" represents decimal point (example: 24R3 = 24.3 Ω) $\geq 100 \Omega$.....First three digits are significant, fourth digit represents number of zeros to follow (example: 8252 = 82.5K Ω) <u>5 % Tolerance:</u> $\geq 10 \Omega$.....First two digits are significant, third digit represents number of zeros to follow (example: 474 = 470K Ω)</p> <p>Packaging _____ E = 5,000 pieces on 180 mm (7 inch) plastic reel, paper tape - CMP0603Q, CMP0805Q, CMP1206Q 4,000 pieces on 180 mm (7 inch) reel, plastic tape - CMP2010Q, CMP2512Q</p> <p>Termination _____ LF = Tin-plated (RoHS Compliant)</p>	<p>CMP</p> <p>0603</p> <p>Q</p> <p>F</p> <p>X</p> <p>-</p> <p>1002</p> <p>E</p> <p>LF</p>
--	---

CMP-Q Series High Power Anti-Surge Chip Resistors

BOURNS®

Performance Characteristics

Test Item	Method	Procedure	Test Limits ΔR
Electrical Characteristics	AEC-Q200 Table 7.1	Measure the resistance value	DC Resistance: F: $\pm 1\%$; J: $\pm 5\%$ TCR: Within specifications
High Temperature Exposure (Storage)	AEC-Q200 Table 7.3	1000 hours @ T = 125 °C unpowered; Measurement at 24 ± 2 hours after test conclusion	J: $\Delta R \leq \pm(3\% + 0.1 \Omega)$ F: $\Delta R \leq \pm(1\% + 0.05 \Omega)$
Temperature Cycling	AEC-Q200 Table 7.4	1000 cycles (-55 °C to +125 °C); Measurement at 24 ± 2 hours after test conclusion	J: $\Delta R \leq \pm(1\% + 0.1 \Omega)$ F: $\Delta R \leq \pm(0.5\% + 0.05 \Omega)$ No mechanical damage
Moisture Resistance	AEC-Q200 Table 7.6	Test 65 °C / 80-100 % RH / 10 cycles; Measurement at 24 ± 2 hours after test conclusion (t = 24 hours/cycle)	J: $\Delta R \leq \pm(1\% + 0.1 \Omega)$ F: $\Delta R \leq \pm(0.5\% + 0.05 \Omega)$
Biased Humidity	AEC-Q200 Table 7.7	1000 hours 85 °C / 85 % RH, 10 % of operating power; Measurement at 24 ± 2 hours after test conclusion	J: $\Delta R \leq \pm(3\% + 0.1 \Omega)$ F: $\Delta R \leq \pm(1\% + 0.05 \Omega)$
Operational Life	AEC-Q200 Table 7.8	Test 1000 hours @ T _A = 125 °C at specified rated power; Measurement at 24 ± 2 hours after test conclusion	J: $\Delta R \leq \pm(3\% + 0.1 \Omega)$ F: $\Delta R \leq \pm(1\% + 0.05 \Omega)$
Mechanical Shock	AEC-Q200 Table 7.13	Test peak value: 100 g's, wave: hail-sine; Duration: 6 ms, Velocity: 12.3 ft/sec.	Within product specification tolerance and no visible damage
Vibration	AEC-Q200 Table 7.14	5 g's for 20 min., 12 cycles each of 3 orientations; Test from 10-2000 Hz	J: $\Delta R \leq \pm(1\% + 0.1 \Omega)$ F: $\Delta R \leq \pm(0.5\% + 0.05 \Omega)$ No mechanical damage
Resistance to Solder Heat	AEC-Q200 Table 7.15	Solder dipping @ 270 °C ± 5 °C for 10 sec. ± 1 sec.	J: $\Delta R \leq \pm(1\% + 0.1 \Omega)$ F: $\Delta R \leq \pm(0.5\% + 0.05 \Omega)$ No mechanical damage
Thermal Shock	AEC-Q200 Table 7.16	-55 to 155 °C / dwell time 15 min / max transfer time 20 sec / 300 cycles	J: $\Delta R \leq \pm(1\% + 0.1 \Omega)$ F: $\Delta R \leq \pm(0.5\% + 0.05 \Omega)$ No mechanical damage
ESD	AEC-Q200-002	Test contact min. 1 kV	$\Delta R \leq \pm(1\% + 0.1 \Omega)$
Solderability	AEC-Q200 Table 7.18	a) Baking 155 °C 4H, dipping 235 °C 5 sec b) Steam 8H, dipping 215 °C 5 sec c) Steam 8H, dipping 260 °C 7 sec	Over 95 % of termination must be covered with solder
Flammability	AEC-Q200 Table 7.20	UL-94 V-0 or V-1 are acceptable	Refer UL-94
Board Flex	AEC-Q200 Table 7.21	Bending 2 mm (2512Q, 1206Q), 3 mm (0805Q, 0603Q)	J: $\Delta R \leq \pm(1\% + 0.1 \Omega)$ F: $\Delta R \leq \pm(0.5\% + 0.05 \Omega)$ No mechanical damage
Terminal Strength	AEC-Q200 Table 7.22	Force 1.8 Kg for 60 sec	No mechanical damage

Specifications are subject to change without notice.

Users should verify actual device performance in their specific applications.

The products described herein and this document are subject to specific legal disclaimers as set forth on the last page of this document, and at www.bourns.com/docs/legal/disclaimer.pdf.

CMP-Q Series High Power Anti-Surge Chip Resistors

BOURNS®

Typical Part Marking

±5 % (E24):

CMP0603Q, CMP0805Q, CMP1206Q, CMP2010Q, CMP2512Q

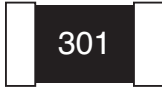

Resistance value is expressed by 3 digits. The first two digits represent the significant figures of the nominal resistance value in ohms; the third digit represents the exponent for a base of 10.

Example: 301 = 30 x 10¹ = 300 ohms

±1 % (E24/E96):

CMP0805Q, CMP1206Q, CMP2010Q, CMP2512Q

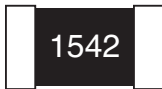

Resistance value is expressed by 4 digits. The first three digits represent the significant figures of the nominal resistance value in ohms; the third digit represents the exponent for a base of 10.

Example: 1542 = 154 x 10² = 15.4K ohms

±1 % (E24):

CMP0603Q



Resistance value is expressed by 3 digits. The first two digits represent the significant figures of the nominal resistance value in ohms; the third digit represents the exponent for a base of 10.

Example: 222 = 22 x 10² = 2.2K ohms

±1 % (E96):

CMP0603Q



Resistance value is expressed by 2 digits followed by an alpha character multiplier. (Refer to marking table below.)

Example: 01B = 100 x 10¹ = 1K ohms

This table shows the first two digits for the three-digit E96 part marking scheme. The third character is a letter multiplier:

A=10⁰
 B=10¹
 C=10²
 D=10³
 E=10⁴
 F=10⁵
 G=10⁶
 H=10⁷
 X=10⁻¹
 Y=10⁻²
 Z=10⁻³

Code	R Value	Code	R Value	Code	R Value	Code	R Value	Code	R Value
01	100	21	162	41	261	61	422	81	681
02	102	22	165	42	267	62	432	82	698
03	105	23	169	43	274	63	442	83	715
04	107	24	174	44	280	64	453	84	732
05	110	25	178	45	287	65	464	85	750
06	113	26	182	46	294	66	475	86	768
07	115	27	187	47	301	67	487	87	787
08	118	28	191	48	309	68	499	88	806
09	121	29	196	49	316	69	511	89	825
10	124	30	200	50	324	70	523	90	845
11	127	31	205	51	332	71	536	91	866
12	130	32	210	52	340	72	549	92	887
13	133	33	215	53	348	73	562	93	909
14	137	34	221	54	357	74	576	94	931
15	140	35	226	55	365	75	590	95	953
16	143	36	232	56	374	76	604	96	976
17	147	37	237	57	383	77	619		
18	150	38	243	58	392	78	634		
19	154	39	249	59	402	79	649		
20	158	40	255	60	412	80	665		

Specifications are subject to change without notice.

Users should verify actual device performance in their specific applications.

The products described herein and this document are subject to specific legal disclaimers as set forth on the last page of this document, and at www.bourns.com/docs/legal/disclaimer.pdf.

CMP-Q Series High Power Anti-Surge Chip Resistors

BOURNS®

Packaging Dimensions (Conforms to EIA RS-481A)

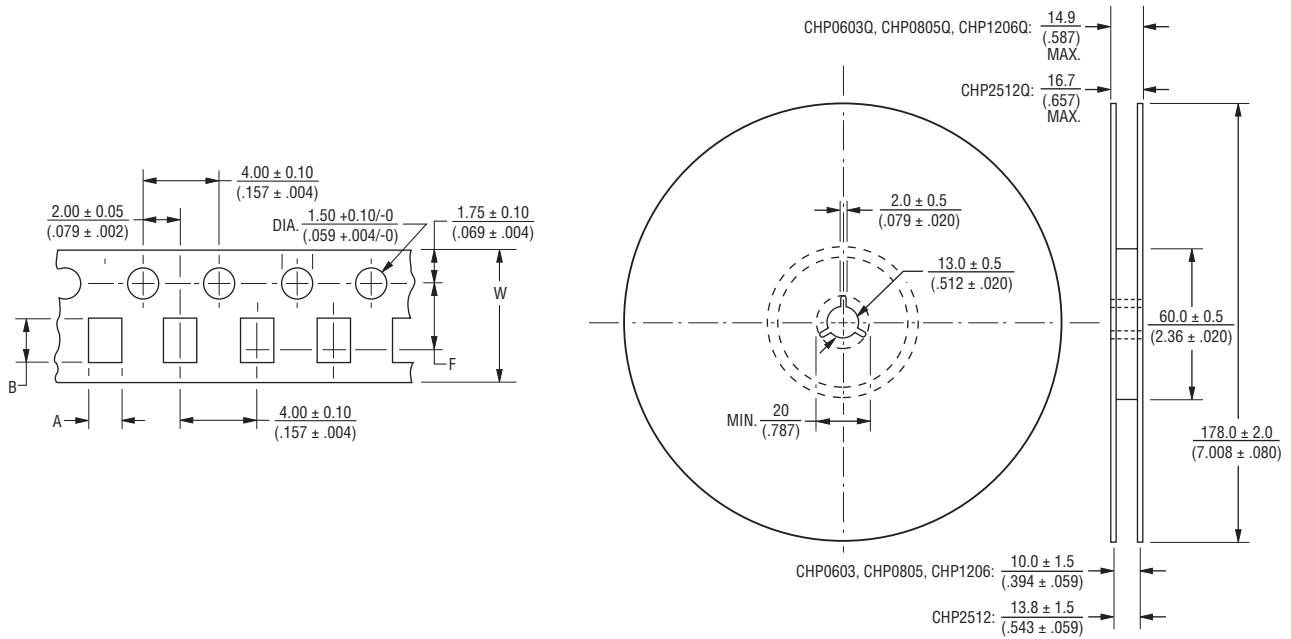

Model	Tape Type	Pieces per Reel	A	B	W	F
CMP0603Q	Paper	5,000	1.10 ± 0.20 (.043 ± .008)	1.90 ± 0.20 (.075 ± .008)	8.00 ± 0.30 (.315 ± .012)	3.50 ± 0.05 (.138 ± .020)
CMP0805Q			1.65 ± 0.20 (.065 ± .008)	2.40 ± 0.20 (.094 ± .008)		
CMP1206Q			2.00 ± 0.20 (.079 ± .008)	3.60 ± 0.20 (.142 ± .008)		
CMP2010Q	Plastic	4,000	2.80 ± 0.20 (.110 ± .008)	5.50 ± 0.20 (.216 ± .008)	12.00 ± 0.30 (.472 ± .012)	5.50 ± 0.05 (.217 ± .020)
CMP2512Q			3.50 ± 0.20 (.138 ± .008)	6.70 ± 0.20 (.264 ± .008)		

DIMENSIONS: $\frac{\text{MM}}{\text{(INCHES)}}$